

# ARTISOL SYSTEM

Die optimale Lösung für  
Fassadendämmung

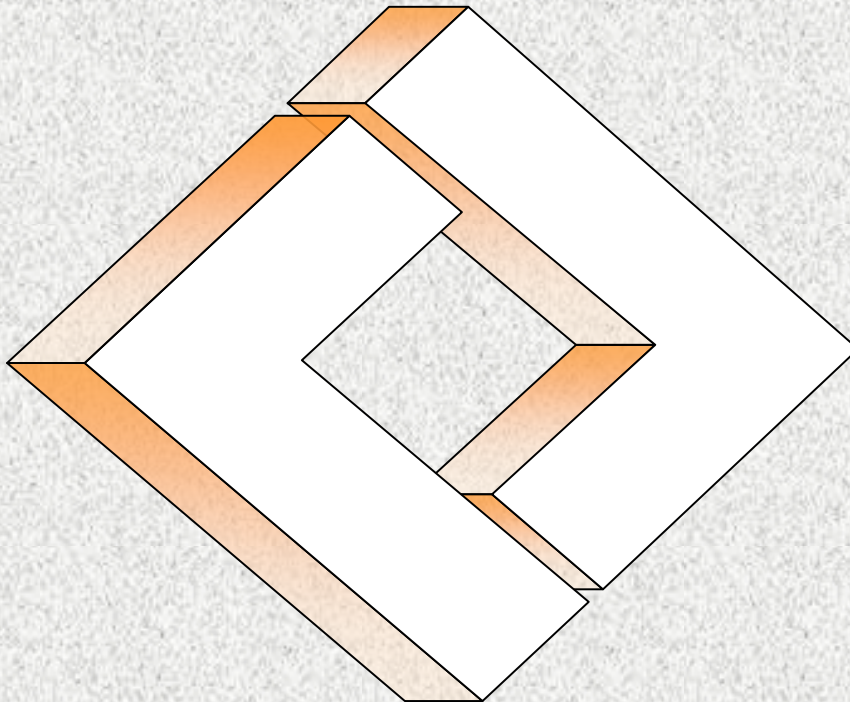

**Fertigelemente für Fassadenecken - Schürzen - Leibungen -  
Rahmenaufdopplungen usw.  
Säulen - Lisenen- Spezialelemente**

**ARTISOL GmbH**  
Ohrbühlstrasse 25 CH-8409 Winterthur  
Tel. 052 / 242 42 13 Fax 052 / 242 42 16  
**[www.artisol-system.com](http://www.artisol-system.com)**  
e-mail [info@artisol-system.com](mailto:info@artisol-system.com)

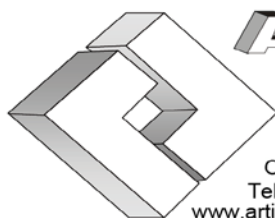

**ARTISOL®  
SYSTEM**

Fassaden-Spezialelemente

**ARTISOL GmbH**

Ohrbühlstr. 25 CH-8409 Winterthur

Tel. 052 / 242 42 13 Fax 052 / 242 42 16

www.artisol-system.com/info@artisol-system.com

## FRA-Winkel FRA-Winkel für die Montage von Geländer zwischen Tür- und Fensterleibung. (Französische Balkone) bzw. Geländermontagen an Gebäudeecken.

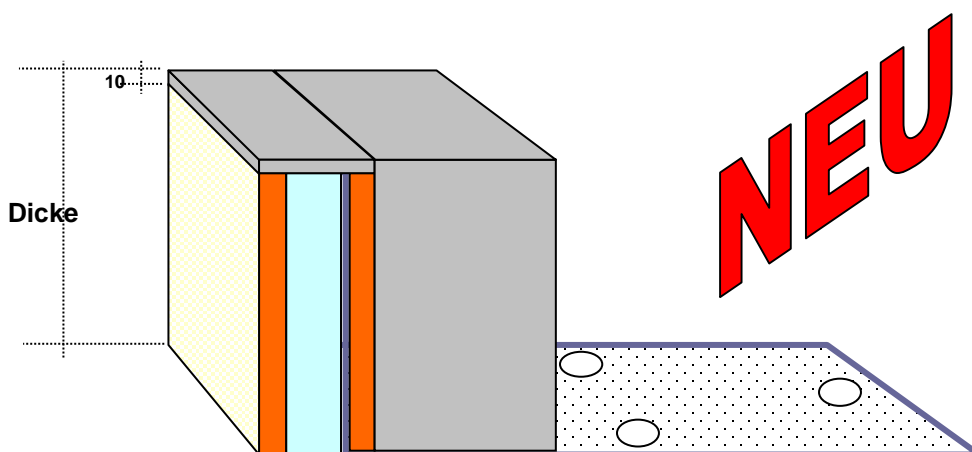

Art. Nr.	Dicke	Bruttopreise
		Fr. / Stk
390-080	80mm	49.30
390-100	100mm	50.50
390-120	120mm	52.35
390-140	140mm	52.95
390-160	160mm	55.90
390-180	180mm	57.35
390-200	200mm	57.95
390-220	220mm	59.00
390-240	240mm	61.10
390-260	260mm	61.95
390-280	280mm	63.35
390-300	300mm	64.80
Inkl.3 Schraubdübel pro Element		

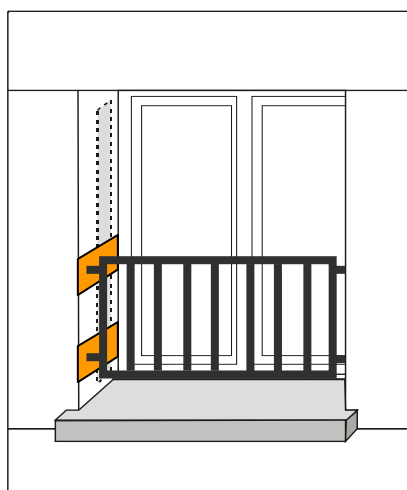

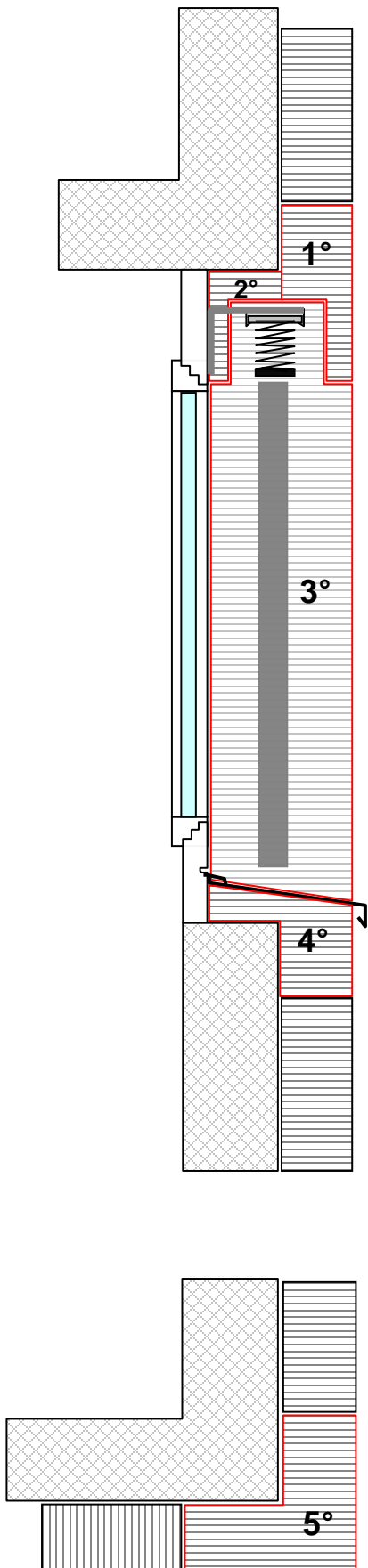

Artisol Top Services, Lieferfristen	S.1
-------------------------------------	-----

1° Schürzenelemente - Sturz	S.2-3
-----------------------------	-------

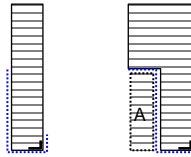

2° Rahmenelemente	S.4-5
-------------------	-------

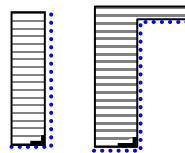

3° Leibungs-, Gewände- und Ladeklöbenelemente	S.6-15
---	--------

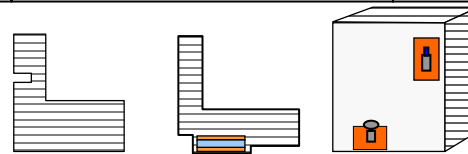

4° Fensterbank	S.16
----------------	------

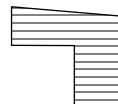

5° Eckenelemente	S.17
------------------	------

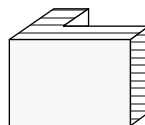

Kombiniertes Programm	S.18-22
-----------------------	---------

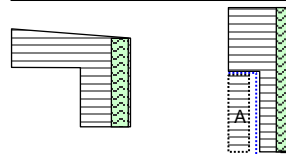

Mineralisches Programm	
------------------------	--

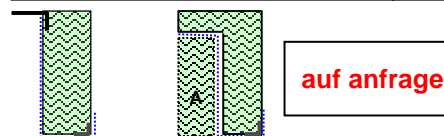

Verschiedene Spezialelemente Lisenen, Säulen u.s.w.	
--	--

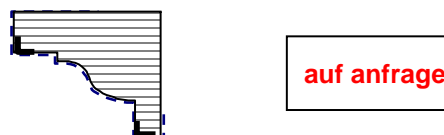

Verkauf- und Lieferbedingungen	23
--------------------------------	----



Wir sind für Sie da von Montag bis Freitag 7.30 - 12.00 Uhr und 13.00 - 17.00 Uhr

Tel. 052 242 242 42 13. Fax 052 242 42 16

übrige Zeit unter:

[www.artisol-system.com](http://www.artisol-system.com) / [info@artisol-system.com](mailto:info@artisol-system.com)

Kontakt - Bestellungen



## Top Service

Zur Bestellung unserer Produkte bieten wir Ihnen nach Absprache den Service, die Massaufnahmen vor Ort am Objekt zusammen zu machen.



## Top Abhol-Service

Natürlich liefern wir unsere Produkte sehr gerne.  
Abholer profitieren aber auch - nämlich von einem Abholrabatt!



## Top Zuschnitt-Service

Wir haben die Lösung für Ihre Anwendung. Auch EPS Materialien werden nebst den Standardelementen für Sie massgeschneidert, konfektioniert und sind so perfekt auf Ihre Bedürfnisse abgestimmt.

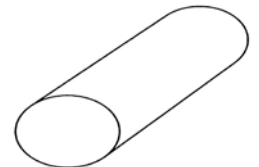
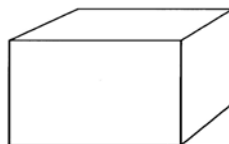
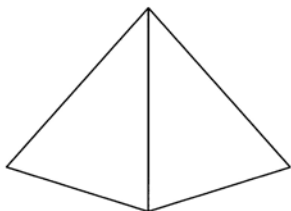

## Top Swiss-Quality

Unsere mittel- und langfristig kostengünstigen Produkte stehen für extreme Langlebigkeit und hohe Schadensresistenz. Die hervorragende Verarbeitung ermöglicht Ihnen die massive Senkung Ihrer Arbeitszeit.



**EPS - Schürzenelement mit PVC Winkel, Schiene und Gewebeeinbettung N°400**

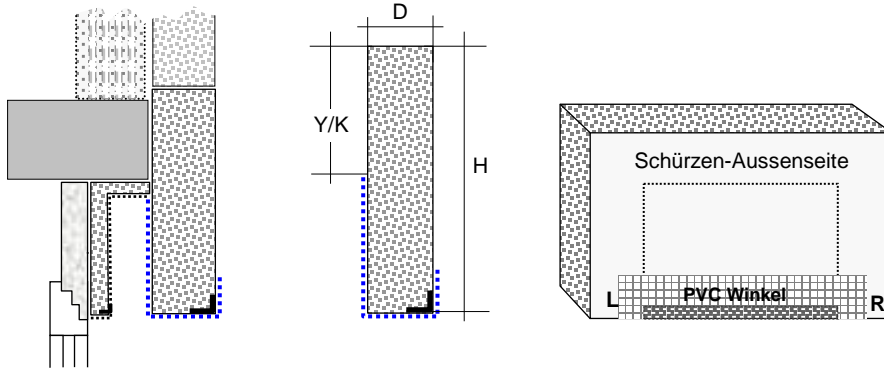

Länge nach Angabe  
Y/K = Variabel (Klebefläche)  
Auf Anfrage andere Höhe

Höhe 500 mm		EPS 20
Artikel Nr.	Dicke	Fr. / m <sup>1</sup>
400.452	20mm	53.04
400.453	30mm	50.50
400.454	40mm	51.25
400.455	50mm	53.80
400.456	60mm	55.59
400.457	70mm	56.30
400.458	80mm	58.10
400.459	90mm	60.05
400.460	100mm	61.35
400.461	110mm	63.95
400.462	120mm	65.15
400.463	130mm	67.05
400.464	140mm	69.20
400.465	150mm	70.20
400.466	160mm	72.70
400.467	170mm	73.95
400.468	180mm	75.85
400.469	190mm	77.80
400.470	200mm	79.56

**EPS - Aufdoppelung N° 440**

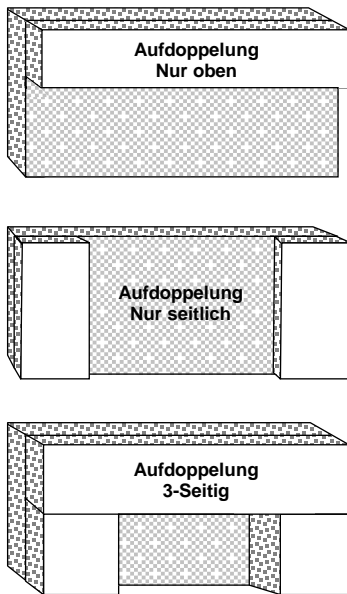

Aufdoppelung  
Nur oben oder Nur seitlich

Artikel Nr.	Stärke	Fr. / m <sup>1</sup>
440.831	10mm	10.75
440.832	20mm	10.75
440.833	30mm	11.30
440.834	40mm	11.80
440.835	50mm	12.35
440.836	60mm	12.90
440.837	70mm	13.95
440.838	80mm	15.00
440.839	90mm	15.60
440.840	100mm	16.10
440.841	110mm	17.70
440.842	120mm	18.80
440.843	130mm	19.30
440.844	140mm	19.85
440.845	150mm	20.95
440.846	160mm	21.45
440.847	170mm	22.00
440.848	180mm	22.50
440.849	190mm	23.60
440.850	200mm	24.65

Aufdoppelung  
3-Seitig

Artikel Nr.	Stärke	Fr. / m <sup>1</sup>
440.931	10mm	15.00
440.932	20mm	15.00
440.933	30mm	15.60
440.934	40mm	16.10
440.935	50mm	16.65
440.936	60mm	17.70
440.937	70mm	18.80
440.938	80mm	19.85
440.939	90mm	20.40
440.940	100mm	20.95
440.941	110mm	22.00
440.942	120mm	23.10
440.943	130mm	23.60
440.944	140mm	24.15
440.945	150mm	25.20
440.946	160mm	25.75
440.947	170mm	26.30
440.948	180mm	26.80
440.949	190mm	27.85
440.950	200mm	29.50

**Zuschläge:**

\*

**Vormontierter Montagewinkel**

für Balkondecke, Artikel Nr. 480.001 Pro Stück Fr. 19.30

Zuschlag für Ausführung in **EPS grau** Fr.6.00/ml

480.007 **Mehrhöhe** pro cm Fr.-.70/ml

480.915 **Minderhöhe** <500mm Fr.2.-./ml

480.008 **Mehrlänge** 3001-4500mm Fr.2.50/ml

480.004 ab **4500mm Dilatation Längestösse** mit Gewebe und Metallschiene Fr. 23.85/Stk.

480.015 Integrierter **PVC Tropfkanteprofil** Fr.20.95/ml

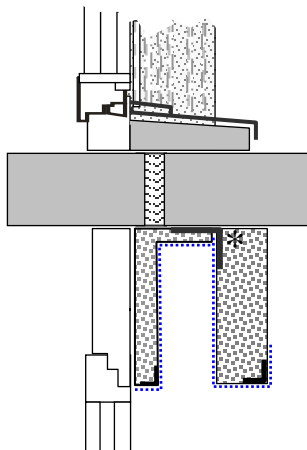

**EPS - Schürzenelement mit PVC Winkel, Schiene und Gewebeeinbettung N°400-S/C**

Höhe 500 mm		EPS 30
Artikel Nr.	Dicke	Fr. / m <sup>1</sup>
400.502-S/C	25mm*	101.65
400.503-S/C	35mm*	103.30

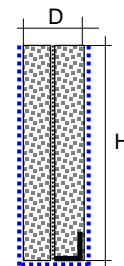

25mm\* / 35mm mit Gewebeeinbettung innen\* und aussen

**EPS - Schürzenelement mit PVC Winkel, Schiene und Gewebeeinbettung N°403**

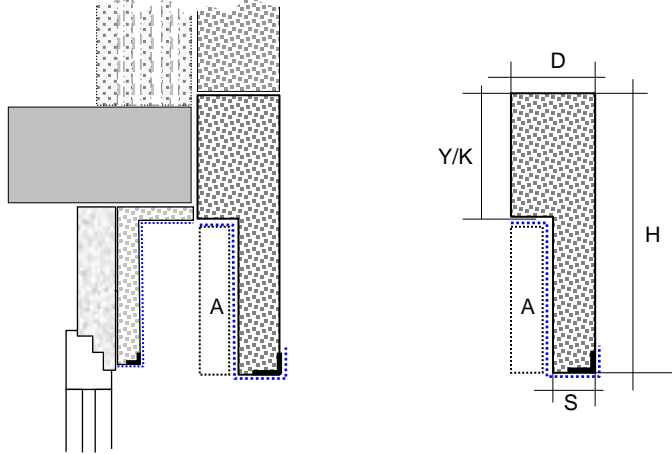

**EPS - Aufdoppelung 3-Seitig inklusiv**

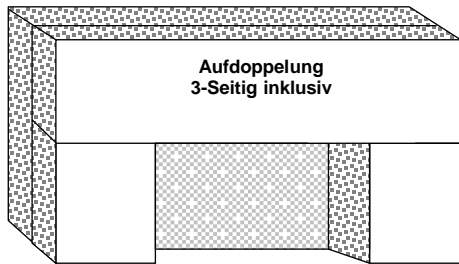

Länge nach Angabe  
Y/K = Variabel ( Klebefläche )  
Auf Anfrage andere Höhe

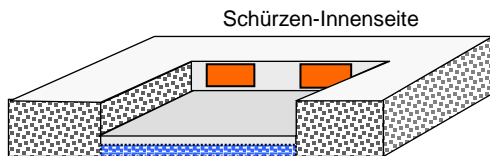

480.015 **Auf Anfrage** integrierte Montageplatte für Storen  
Fr.28.90/Stk.

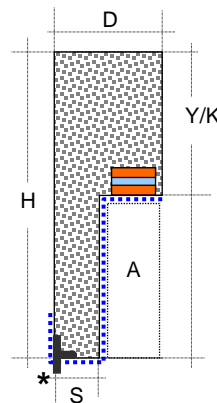

**Zuschläge :**

**Vormontierter Montagewinkel**

für Balkondecke, Artikel Nr. 480.001 Pro Stück Fr. 19.30

Zuschlag für Ausführung in **EPS grau** Fr.6.00/ml

480.007 **Mehrhöhe** pro cm Fr.-.70/ml

480.915 **Minderhöhe** <500mm Fr.2.--/ml

480.008 **Mehrlänge** 3001-4500mm Fr.2.50/ml

480.004 ab **4500mm Dilatation Längestösse** mit Gewebe und Metallschiene Fr. 23.85/Stk.

480.015 Integrierter **PVC Tropfkanteprofil** Fr.20.95/ml

Höhe 500 mm			EPS20
Artikel Nr.	Dicke	Stärke	Fr./m'
403.203	80mm	30mm	67.10
403.204	80mm	40mm	67.30
403.205	80mm	50mm	69.30
403.206	80mm	60mm	70.60
403.207	80mm	70mm	71.25
403.303	100mm	30mm	69.30
403.304	100mm	40mm	68.90
403.305	100mm	50mm	70.40
403.306	100mm	60mm	71.70
403.307	100mm	70mm	71.80
403.408	100mm	80mm	73.10
403.309	100mm	90mm	75.00
403.403	120mm	30mm	70.85
403.404	120mm	40mm	71.05
403.405	120mm	50mm	72.50
403.406	120mm	60mm	73.30
403.407	120mm	70mm	72.90
403.408	120mm	80mm	74.15
403.409	120mm	90mm	75.60
403.410	120mm	100mm	75.15
403.411	120mm	110mm	78.90
403.503	140mm	30mm	72.50
403.504	140mm	40mm	72.10
403.505	140mm	50mm	74.10
403.506	140mm	60mm	75.45
403.507	140mm	70mm	75.00
403.508	140mm	80mm	75.80
403.509	140mm	90mm	76.70
403.510	140mm	100mm	76.20
403.511	140mm	110mm	79.50
403.512	140mm	120mm	80.10
403.513	140mm	130mm	82.00
403.603	160mm	30mm	74.05
403.604	160mm	40mm	74.30
403.605	160mm	50mm	75.75
403.606	160mm	60mm	76.50
403.607	160mm	70mm	76.60
403.608	160mm	80mm	77.95
403.609	160mm	90mm	78.80
403.610	160mm	100mm	77.85
403.611	160mm	110mm	80.55
403.612	160mm	120mm	81.20
403.613	160mm	130mm	82.60
403.614	160mm	140mm	84.15
403.615	160mm	150mm	85.20
403.703	180mm	30mm	75.70
403.704	180mm	40mm	75.35
403.705	180mm	50mm	77.30
403.706	180mm	60mm	78.65
403.707	180mm	70mm	78.25
403.708	180mm	80mm	79.00
403.709	180mm	90mm	80.40
403.710	180mm	100mm	80.00
403.711	180mm	110mm	82.70
403.712	180mm	120mm	82.85
403.713	180mm	130mm	83.65
403.714	180mm	140mm	85.20
403.715	180mm	150mm	85.75
403.716	180mm	160mm	87.70
403.717	180mm	170mm	88.95
403.803	200mm	30mm	76.80
403.804	200mm	40mm	76.90
403.805	200mm	50mm	78.95
403.806	200mm	60mm	79.70
403.807	200mm	70mm	79.80
403.808	200mm	80mm	81.15
403.809	200mm	90mm	82.00
403.810	200mm	100mm	81.05
403.811	200mm	110mm	84.25
403.812	200mm	120mm	85.00
403.813	200mm	130mm	85.80
403.815	200mm	140mm	86.90
403.816	200mm	150mm	86.80
403.817	200mm	160mm	88.75
403.818	200mm	170mm	89.50
403.819	200mm	180mm	90.85
403.820	200mm	190mm	92.80

**EPS- Rahmenelement mit Gewebewinkel und Gewebeeinbettung N°460**

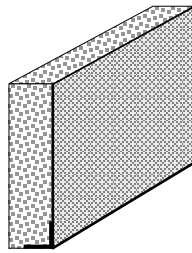
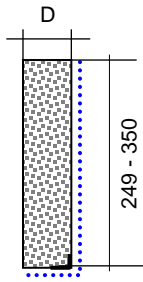

Höhe 249 - 350 mm  
Auf Anfrage auch andere Höhe

Länge 1000 mm	Länge nach Angabe		EPS 20
Fr. / m <sup>1</sup>	Artikel Nr.	Dicke	Fr. / m <sup>1</sup>
27.05	460.202*	20mm*	34.05
30.20	460.203	30mm	37.20
33.55	460.204	40mm	40.55
35.50	460.205	50mm	42.50
38.20	460.206	60mm	45.20
47.55	460.207	70mm	54.55
43.75	460.208	80mm	50.75
52.70	460.209	90mm	59.70
49.10	460.210	100mm	56.10
57.95	461.211	110mm	64.95
53.85	462.212	120mm	60.85
Standardlänge	EPS 30*		

**Extrudiertes Polystyrol-Rahmenelement mit Gewebewinkel und Gewebeeinbettung N°470**

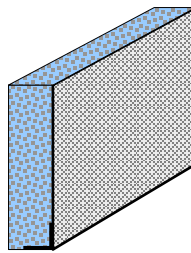
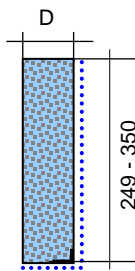

Höhe 249 - 350 mm  
Auf Anfrage auch andere Höhe

Länge 1000 mm	Länge nach Angabe		XPS
Fr. / m <sup>1</sup>	Artikel Nr.	Dicke	Fr. / m <sup>1</sup>
32.55	470.302	20mm	39.55
35.70	470.303	30mm	42.70
39.05	470.304	40mm	46.05
41.00	470.305	50mm	48.00
43.70	470.306	60mm	50.70
53.05	470.307	70mm	60.05
49.25	470.308	80mm	56.25
58.20	470.309	90mm	65.20
54.60	470.310	100mm	61.60
63.45	470.311	110mm	70.45
59.35	470.312	120mm	66.35
Standardlänge			

**EPS - Sturzelement beschichtet mit Mörtel N°465**

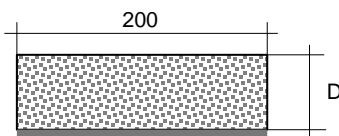

Länge 1000 oder 1250mm  
Auf Anfrage auch andere Breite

	Länge nach Angabe		EPS 20
Fr. / m <sup>1</sup>	Artikel Nr.	Dicke	Fr. / m <sup>1</sup>
14.85	465.402*	20mm	21.85
15.95	465.403	30mm	22.95
17.05	465.404	40mm	24.05
17.60	465.405	50mm	24.60
18.15	465.406	60mm	25.15
19.20	465.407	70mm	26.20
19.80	465.408	80mm	26.80
20.30	465.409	90mm	27.30
21.40	465.410	100mm	28.40
21.95	466.411	110mm	28.95
23.10	467.412	120mm	30.10
Standardlänge	EPS 30*		

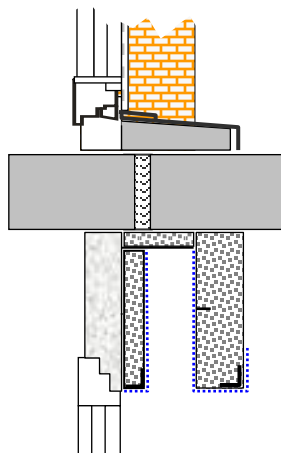

**EPS - Sturz - Rahmenelement mit Gewebewinkel und Geweeinbettung N°490**

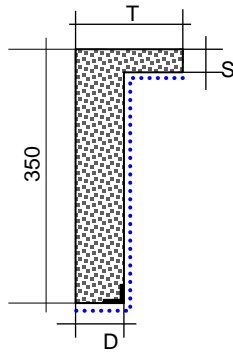

Länge nach Angabe  
 T = Schenkellänge aussen bis 250mm  
 Auf Anfrage auch andere Höhe

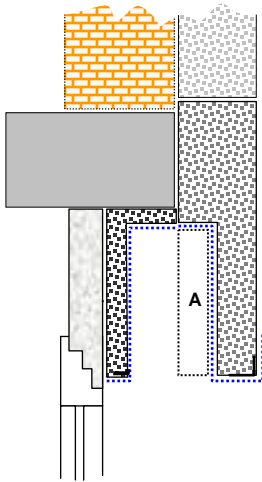
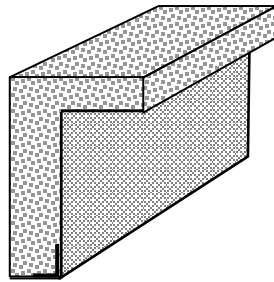

Artikel Nr.	Höhe 350 mm		EPS 20 Fr. / m <sup>3</sup>
	Dicke	Stärke	
490.202	20mm*	20mm	55.60
490.203	20mm*	30mm	55.60
490.204	20mm*	40mm	55.60
490.205	20mm*	50mm	55.60
490.206	20mm*	60mm	55.60
490.207	20mm*	70mm	55.60
490.208	20mm*	80mm	55.60
490.209	20mm*	90mm	55.60
490.210	20mm*	100mm	55.60
490.302	30mm	20mm	55.60
490.303	30mm	30mm	55.60
490.304	30mm	40mm	55.60
490.305	30mm	50mm	55.60
490.306	30mm	60mm	55.60
490.307	30mm	70mm	55.60
490.308	30mm	80mm	55.60
490.309	30mm	90mm	55.60
490.310	30mm	100mm	55.60
490.402	40mm	20mm	56.80
490.403	40mm	30mm	56.80
490.404	40mm	40mm	56.80
490.405	40mm	50mm	56.80
490.406	40mm	60mm	56.80
490.407	40mm	70mm	56.80
490.408	40mm	80mm	56.80
490.409	40mm	90mm	56.80
490.410	40mm	100mm	56.80
490.502	50mm	20mm	58.70
490.503	50mm	30mm	58.70
490.504	50mm	40mm	58.70
490.505	50mm	50mm	58.70
490.506	50mm	60mm	58.70
490.507	50mm	70mm	58.70
490.508	50mm	80mm	58.70
490.509	50mm	90mm	58.70
490.510	50mm	100mm	58.70
490.602	60mm	20mm	60.00
490.603	60mm	30mm	60.00
490.604	60mm	40mm	60.00
490.605	60mm	50mm	60.00
490.606	60mm	60mm	60.00
490.607	60mm	70mm	60.00
490.608	60mm	80mm	60.00
490.609	60mm	90mm	60.00
490.610	60mm	100mm	60.00
490.702	70mm	20mm	61.20
490.703	70mm	30mm	61.20
490.704	70mm	40mm	61.20
490.705	70mm	50mm	61.20
490.706	70mm	60mm	61.20
490.707	70mm	70mm	61.20
490.708	70mm	80mm	61.20
490.709	70mm	90mm	61.20
490.710	70mm	100mm	61.20
490.802	80mm	20mm	62.45
490.803	80mm	30mm	62.45
490.804	80mm	40mm	62.45
490.805	80mm	50mm	62.45
490.806	80mm	60mm	62.45
490.807	80mm	70mm	62.45
490.808	80mm	80mm	62.45
490.809	80mm	90mm	62.45
490.810	80mm	100mm	62.45
490.902	90mm	20mm	64.40
490.903	90mm	30mm	64.40
490.904	90mm	40mm	64.40
490.905	90mm	50mm	64.40
490.906	90mm	60mm	64.40
490.907	90mm	70mm	64.40
490.908	90mm	80mm	64.40
490.909	90mm	90mm	64.40
490.910	90mm	100mm	64.40

Artikel Nr.	Höhe 350 mm		EPS 20 Fr. / m <sup>3</sup>
	Dicke	Stärke	
490.1002	100mm	20mm	65.80
490.1003	100mm	30mm	65.80
490.1004	100mm	40mm	65.80
490.1005	100mm	50mm	65.80
490.1006	100mm	60mm	65.80
490.1007	100mm	70mm	65.80
490.1008	100mm	80mm	65.80
490.1009	100mm	90mm	65.80
490.1010	100mm	100mm	65.80



## EPS - Leibungs- und Sturzelement N°301

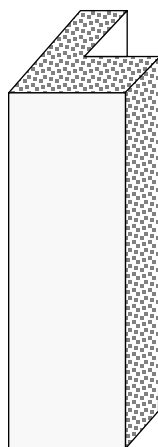
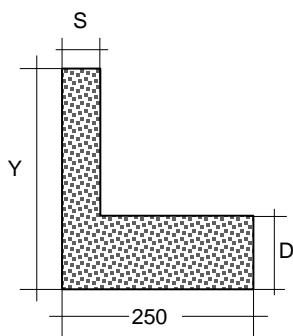

Länge 1000 mm  
 Fassade / Leibung  
 Schenkellänge aussen 250 / 250 mm  
 Typ \*120 - \*200 250 / 300 mm  
 Y = Leibungsschenkellänge variabel  
 Leibung Stärke 20mm auf Anfrage  
 Auf Anfrage  
 integrierte Montageplatte für Geländer Nr.390-G

Artikel Nr.	Dicke	Stärke	EPS 20
			Fr. / m <sup>3</sup>
301.202	80mm	20mm	
301.203	80mm	30mm	<b>19.45</b>
301.204	80mm	40mm	<b>19.45</b>
301.205	80mm	50mm	<b>19.45</b>
301.206	80mm	60mm	<b>19.45</b>
301.207	80mm	70mm	<b>19.45</b>
301.208	80mm	80mm	<b>19.45</b>
301.209	80mm	90mm	<b>19.45</b>
301.210	80mm	100mm	<b>19.45</b>
301.302	100mm	20mm	
301.303	100mm	30mm	<b>21.10</b>
301.304	100mm	40mm	<b>21.10</b>
301.305	100mm	50mm	<b>21.10</b>
301.306	100mm	60mm	<b>21.10</b>
301.307	100mm	70mm	<b>21.10</b>
301.308	100mm	80mm	<b>21.10</b>
301.309	100mm	90mm	<b>21.10</b>
301.310	100mm	100mm	<b>21.10</b>
301.402	*120mm	20mm	
301.403	*120mm	30mm	<b>23.30</b>
301.404	*120mm	40mm	<b>23.30</b>
301.405	*120mm	50mm	<b>23.30</b>
301.406	*120mm	60mm	<b>23.30</b>
301.407	*120mm	70mm	<b>23.30</b>
301.408	*120mm	80mm	<b>23.30</b>
301.409	*120mm	90mm	<b>23.30</b>
301.410	*120mm	100mm	<b>23.30</b>
301.502	*140mm	20mm	
301.503	*140mm	30mm	<b>24.30</b>
301.504	*140mm	40mm	<b>24.30</b>
301.505	*140mm	50mm	<b>24.30</b>
301.506	*140mm	60mm	<b>24.30</b>
301.507	*140mm	70mm	<b>24.30</b>
301.508	*140mm	80mm	<b>24.30</b>
301.509	*140mm	90mm	<b>24.30</b>
301.510	*140mm	100mm	<b>24.30</b>
301.602	*160mm	20mm	
301.603	*160mm	30mm	<b>26.00</b>
301.604	*160mm	40mm	<b>26.00</b>
301.605	*160mm	50mm	<b>26.00</b>
301.606	*160mm	60mm	<b>26.00</b>
301.607	*160mm	70mm	<b>26.00</b>
301.608	*160mm	80mm	<b>26.00</b>
301.609	*160mm	90mm	<b>26.00</b>
301.610	*160mm	100mm	<b>26.00</b>
301.702	*180mm	20mm	
301.703	*180mm	30mm	<b>27.60</b>
301.704	*180mm	40mm	<b>27.60</b>
301.705	*180mm	50mm	<b>27.60</b>
301.706	*180mm	60mm	<b>27.60</b>
301.707	*180mm	70mm	<b>27.60</b>
301.708	*180mm	80mm	<b>27.60</b>
301.709	*180mm	90mm	<b>27.60</b>
301.710	*180mm	100mm	<b>27.60</b>
301.802	*200mm	20mm	
301.803	*200mm	30mm	<b>29.20</b>
301.804	*200mm	40mm	<b>29.20</b>
301.805	*200mm	50mm	<b>29.20</b>
301.806	*200mm	60mm	<b>29.20</b>
301.807	*200mm	70mm	<b>29.20</b>
301.808	*200mm	80mm	<b>29.20</b>
301.809	*200mm	90mm	<b>29.20</b>
301.810	*200mm	100mm	<b>29.20</b>

Zuschlag für Ausführung in EPS grau Fr.6.50/ml

**EPS - Leibung mit Metalleinlage zur Befestigung der Rolladenschiene N°301 - R**

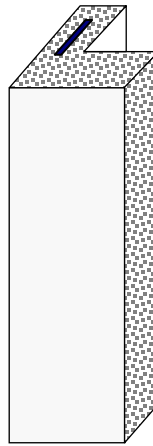
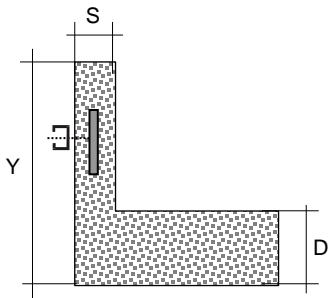

**Fassade / Leibung**  
 Schenkellänge aussen 250 / 250 mm  
 Typ \*120 - \*200 250 / 300 mm  
 Länge nach Angabe  
 Y = Leibungsschenkellänge variabel  
 Leibung Stärke 20mm auf Anfrage  
 Auf Anfrage mit PVC Winkel und Gewebeeinbettung  
 Zuschlag Fr.27.30/ml

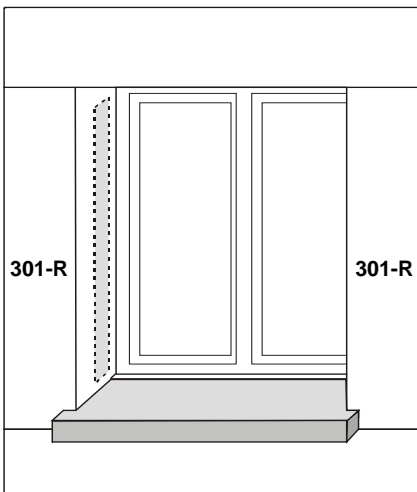
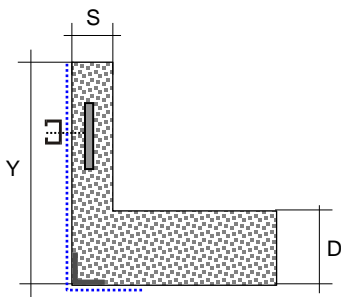

Artikel Nr.	Dicke	Stärke	EPS 20
			Fr. / m <sup>1</sup>
301.202 - R	80mm	20mm	
301.203 - R	80mm	30mm	32.70
301.204 - R	80mm	40mm	32.70
301.205 - R	80mm	50mm	32.70
301.206 - R	80mm	60mm	32.70
301.207 - R	80mm	70mm	32.70
301.208 - R	80mm	80mm	32.70
301.209 - R	80mm	90mm	32.70
301.210 - R	80mm	100mm	32.70
301.302 - R	100mm	20mm	
301.303 - R	100mm	30mm	34.30
301.304 - R	100mm	40mm	34.30
301.305 - R	100mm	50mm	34.30
301.306 - R	100mm	60mm	34.30
301.307 - R	100mm	70mm	34.30
301.308 - R	100mm	80mm	34.30
301.309 - R	100mm	90mm	34.30
301.310 - R	100mm	100mm	34.30
301.402 - R	*120mm	20mm	
301.403 - R	*120mm	30mm	38.05
301.404 - R	*120mm	40mm	38.05
301.405 - R	*120mm	50mm	38.05
301.406 - R	*120mm	60mm	38.05
301.407 - R	*120mm	70mm	38.05
301.408 - R	*120mm	80mm	38.05
301.409 - R	*120mm	90mm	38.05
301.410 - R	*120mm	100mm	38.05
301.502 - R	*140mm	20mm	
301.503 - R	*140mm	30mm	40.20
301.504 - R	*140mm	40mm	40.20
301.505 - R	*140mm	50mm	40.20
301.506 - R	*140mm	60mm	40.20
301.507 - R	*140mm	70mm	40.20
301.508 - R	*140mm	80mm	40.20
301.509 - R	*140mm	90mm	40.20
301.510 - R	*140mm	100mm	40.20
301.602 - R	*160mm	20mm	
301.603 - R	*160mm	30mm	42.35
301.604 - R	*160mm	40mm	42.35
301.605 - R	*160mm	50mm	42.35
301.606 - R	*160mm	60mm	42.35
301.607 - R	*160mm	70mm	42.35
301.608 - R	*160mm	80mm	42.35
301.609 - R	*160mm	90mm	42.35
301.610 - R	*160mm	100mm	42.35
301.702 - R	*180mm	20mm	
301.703 - R	*180mm	30mm	44.50
301.704 - R	*180mm	40mm	44.50
301.705 - R	*180mm	50mm	44.50
301.706 - R	*180mm	60mm	44.50
301.707 - R	*180mm	70mm	44.50
301.708 - R	*180mm	80mm	44.50
301.709 - R	*180mm	90mm	44.50
301.710 - R	*180mm	100mm	44.50
301.802 - R	*200mm	20mm	
301.803 - R	*200mm	30mm	46.60
301.804 - R	*200mm	40mm	46.60
301.805 - R	*200mm	50mm	46.60
301.806 - R	*200mm	60mm	46.60
301.807 - R	*200mm	70mm	46.60
301.808 - R	*200mm	80mm	46.60
301.809 - R	*200mm	90mm	46.60
301.810 - R	*200mm	100mm	46.60

Zuschlag für Ausführung in EPS grau Fr.6.50/ml

**EPS - Leibung mit Kanal zum Versenken der Führungsschiene und Metalleinlage zur Befestigung der Rolladenschiene N°301 - R/V**

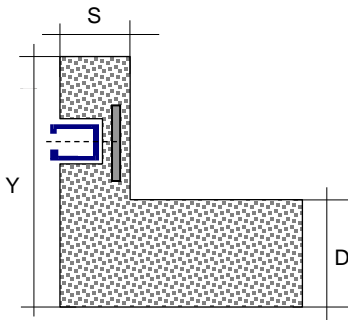

**Fassade / Leibung**

Schenkellänge aussen 250 / 250 mm  
 Typ \*120 - \*200 250 / 300 mm

Kanalmaß variabel  
 Länge nach Angabe  
 y = Leibungsschenkellänge variabel  
 Auf Anfrage mit PVC Winkel und Gewebeeinbettung  
 Zuschlag Gewebeeinbettung Fr.87.25/ml  
 Auf Anfrage auch 0.5-1.5mm verputzt

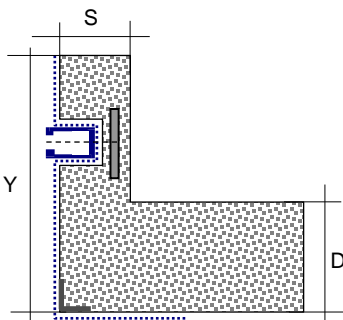
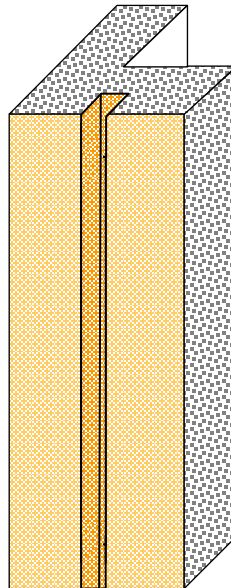

Artikel Nr.	Dicke	Stärke	EPS 20
			Fr. / m <sup>1</sup>
301.205 - R/V	80mm	50mm	42.85
301.206 - R/V	80mm	60mm	42.85
301.207 - R/V	80mm	70mm	42.85
301.208 - R/V	80mm	80mm	42.85
301.209 - R/V	80mm	90mm	42.85
301.210 - R/V	80mm	100mm	42.85
301.305 - R/V	100mm	50mm	44.50
301.306 - R/V	100mm	60mm	44.50
301.307 - R/V	100mm	70mm	44.50
301.308 - R/V	100mm	80mm	44.50
301.309 - R/V	100mm	90mm	44.50
301.310 - R/V	100mm	100mm	44.50
301.405 - R/V	*120mm	50mm	48.80
301.406 - R/V	*120mm	60mm	48.80
301.407 - R/V	*120mm	70mm	48.80
301.408 - R/V	*120mm	80mm	48.80
301.409 - R/V	*120mm	90mm	48.80
301.410 - R/V	*120mm	100mm	48.80
301.505 - R/V	*140mm	50mm	49.85
301.506 - R/V	*140mm	60mm	49.85
301.507 - R/V	*140mm	70mm	49.85
301.508 - R/V	*140mm	80mm	49.85
301.509 - R/V	*140mm	90mm	49.85
301.510 - R/V	*140mm	100mm	49.85
301.605 - R/V	*160mm	50mm	52.50
301.606 - R/V	*160mm	60mm	52.50
301.607 - R/V	*160mm	70mm	52.50
301.608 - R/V	*160mm	80mm	52.50
301.609 - R/V	*160mm	90mm	52.50
301.610 - R/V	*160mm	100mm	52.50
301.705 - R/V	*180mm	50mm	54.60
301.706 - R/V	*180mm	60mm	54.60
301.707 - R/V	*180mm	70mm	54.60
301.708 - R/V	*180mm	80mm	54.60
301.709 - R/V	*180mm	90mm	54.60
301.710 - R/V	*180mm	100mm	54.60
301.805 - R/V	*200mm	50mm	57.85
301.806 - R/V	*200mm	60mm	57.85
301.807 - R/V	*200mm	70mm	57.85
301.808 - R/V	*200mm	80mm	57.85
301.809 - R/V	*200mm	90mm	57.85
301.810 - R/V	*200mm	100mm	57.85

Zuschlag für Ausführung in EPS grau Fr.6.50/ml

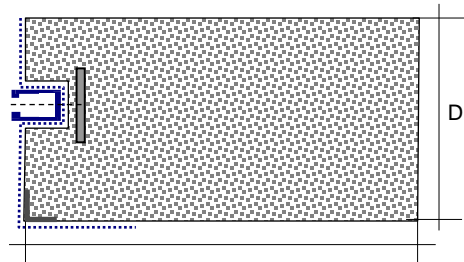
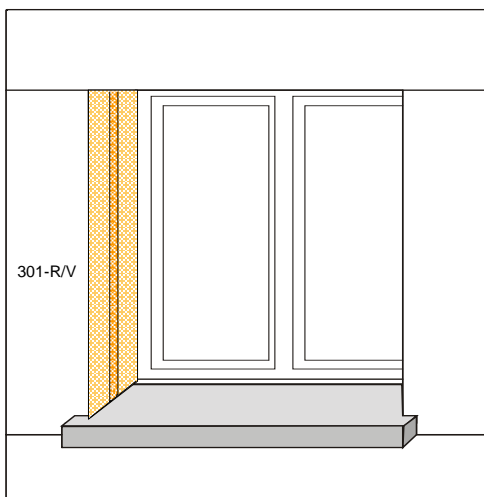

**EPS - Leibungs- und Sturzelement mit Falz N°302**

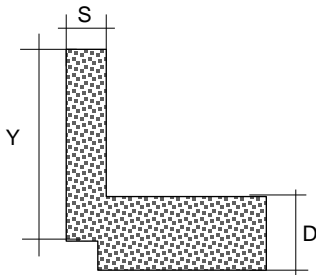

Länge 1000 mm  
**Fassade / Leibung**  
 Schenkellänge aussen 330 / 250 mm  
 Typ \*120 - \*200 330 / 300 mm  
 Falz 30 / 30 mm  
 Y = Leibungsschenkellänge variabel  
 Leibung Stärke 20mm auf Anfrage  
 Auf Anfrage auch Länge nach Angabe,  
 Montageplatte für Ladenkloben,  
 und Rückhalter Fr.22.45/Stk.  
 Zuschlag Gewebeeinbettung Fr.84.65/ml  
 Auf Anfrage auch fein verputzt

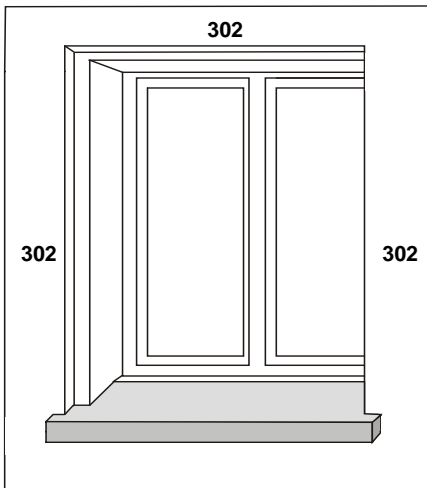
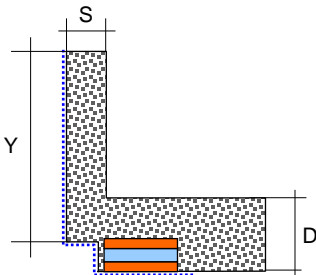

Artikel Nr.	Dicke	Stärke	EPS 20
			Fr. / m <sup>1</sup>
302.202	80mm	20mm	
302.203	80mm	30mm	<b>22.55</b>
302.204	80mm	40mm	<b>22.55</b>
302.205	80mm	50mm	<b>22.55</b>
302.206	80mm	60mm	<b>22.55</b>
302.207	80mm	70mm	<b>22.55</b>
302.208	80mm	80mm	<b>22.55</b>
302.209	80mm	90mm	<b>22.55</b>
302.210	80mm	100mm	<b>22.55</b>
302.302	100mm	20mm	
302.303	100mm	30mm	<b>24.25</b>
302.304	100mm	40mm	<b>24.25</b>
302.305	100mm	50mm	<b>24.25</b>
302.306	100mm	60mm	<b>24.25</b>
302.307	100mm	70mm	<b>24.25</b>
302.308	100mm	80mm	<b>24.25</b>
302.309	100mm	90mm	<b>24.25</b>
302.310	100mm	100mm	<b>24.25</b>
302.402	*120mm	20mm	
302.403	*120mm	30mm	<b>26.40</b>
302.404	*120mm	40mm	<b>26.40</b>
302.405	*120mm	50mm	<b>26.40</b>
302.406	*120mm	60mm	<b>26.40</b>
302.407	*120mm	70mm	<b>26.40</b>
302.408	*120mm	80mm	<b>26.40</b>
302.409	*120mm	90mm	<b>26.40</b>
302.410	*120mm	100mm	<b>26.40</b>
302.502	*140mm	20mm	
302.503	*140mm	30mm	<b>27.40</b>
302.504	*140mm	40mm	<b>27.40</b>
302.505	*140mm	50mm	<b>27.40</b>
302.506	*140mm	60mm	<b>27.40</b>
302.507	*140mm	70mm	<b>27.40</b>
302.508	*140mm	80mm	<b>27.40</b>
302.509	*140mm	90mm	<b>27.40</b>
302.510	*140mm	100mm	<b>27.40</b>
302.602	*160mm	20mm	
302.603	*160mm	30mm	<b>29.10</b>
302.604	*160mm	40mm	<b>29.10</b>
302.605	*160mm	50mm	<b>29.10</b>
302.606	*160mm	60mm	<b>29.10</b>
302.607	*160mm	70mm	<b>29.10</b>
302.608	*160mm	80mm	<b>29.10</b>
302.609	*160mm	90mm	<b>29.10</b>
302.610	*160mm	100mm	<b>29.10</b>
302.702	*180mm	20mm	
302.703	*180mm	30mm	<b>30.70</b>
302.704	*180mm	40mm	<b>30.70</b>
302.705	*180mm	50mm	<b>30.70</b>
302.706	*180mm	60mm	<b>30.70</b>
302.707	*180mm	70mm	<b>30.70</b>
302.708	*180mm	80mm	<b>30.70</b>
302.709	*180mm	90mm	<b>30.70</b>
302.710	*180mm	100mm	<b>30.70</b>
302.802	*200mm	20mm	
302.803	*200mm	30mm	<b>32.30</b>
302.804	*200mm	40mm	<b>32.30</b>
302.805	*200mm	50mm	<b>32.30</b>
302.806	*200mm	60mm	<b>32.30</b>
302.807	*200mm	70mm	<b>32.30</b>
302.808	*200mm	80mm	<b>32.30</b>
302.809	*200mm	90mm	<b>32.30</b>
302.810	*200mm	100mm	<b>32.30</b>

Zuschlag für Ausführung in EPS grau Fr.6.50/ml

**EPS - Leibungs-  
und Sturzelement mit  
Gewände und Falz N°303**

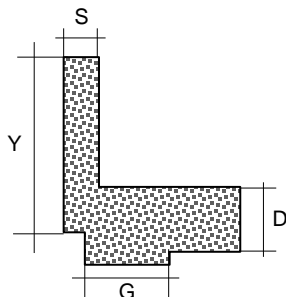

Länge 1000 mm

**Fassade / Leibung**

Schenkellänge aussen 330 / 250 mm

Typ \*120 - \*200 330 / 300 mm

Y = Variabel auf Anfrage

G = Gewände 90 mm, variabel auf Anfrage

Leibung Stärke 20mm auf Anfrage

Auf Anfrage auch Länge nach Angabe,

Montageplatte für Ladenkloben

und Rückhalter Fr.22.45/Stk.

Zuschlag Gewebeeinbettung Fr.93.45/ml

Auf Anfrage auch fein verputzt

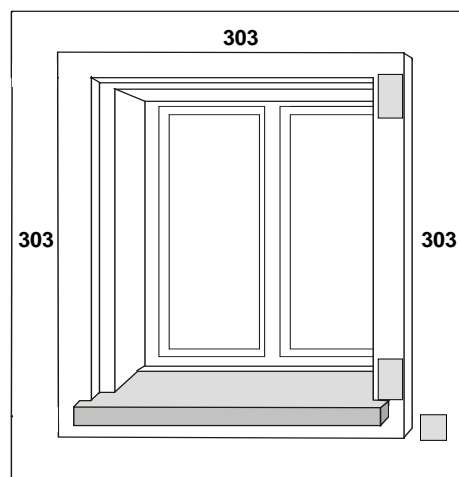
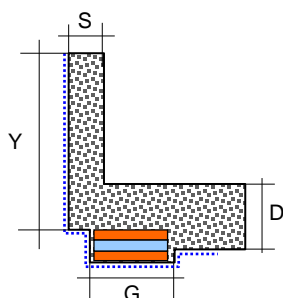

Artikel Nr.	Dicke	Stärke	EPS 20
			Fr. / m <sup>3</sup>
303.202	80mm	20mm	
303.203	80mm	30mm	24.70
303.204	80mm	40mm	24.70
303.205	80mm	50mm	24.70
303.206	80mm	60mm	24.70
303.207	80mm	70mm	24.70
303.208	80mm	80mm	24.70
303.209	80mm	90mm	24.70
303.210	80mm	100mm	24.70
303.302	100mm	20mm	
303.303	100mm	30mm	26.40
303.304	100mm	40mm	26.40
303.305	100mm	50mm	26.40
303.306	100mm	60mm	26.40
303.307	100mm	70mm	26.40
303.308	100mm	80mm	26.40
303.309	100mm	90mm	26.40
303.310	100mm	100mm	26.40
303.402	*120mm	20mm	
303.403	*120mm	30mm	28.50
303.404	*120mm	40mm	28.50
303.405	*120mm	50mm	28.50
303.406	*120mm	60mm	28.50
303.407	*120mm	70mm	28.50
303.408	*120mm	80mm	28.50
303.409	*120mm	90mm	28.50
303.410	*120mm	100mm	28.50
303.502	*140mm	20mm	
303.503	*140mm	30mm	29.55
303.504	*140mm	40mm	29.55
303.505	*140mm	50mm	29.55
303.506	*140mm	60mm	29.55
303.507	*140mm	70mm	29.55
303.508	*140mm	80mm	29.55
303.509	*140mm	90mm	29.55
303.510	*140mm	100mm	29.55
303.602	*160mm	20mm	
303.603	*160mm	30mm	31.30
303.604	*160mm	40mm	31.30
303.605	*160mm	50mm	31.30
303.606	*160mm	60mm	31.30
303.607	*160mm	70mm	31.30
303.608	*160mm	80mm	31.30
303.609	*160mm	90mm	31.30
303.610	*160mm	100mm	31.30
303.702	*180mm	20mm	
303.703	*180mm	30mm	32.85
303.704	*180mm	40mm	32.85
303.705	*180mm	50mm	32.85
303.706	*180mm	60mm	32.85
303.707	*180mm	70mm	32.85
303.708	*180mm	80mm	32.85
303.709	*180mm	90mm	32.85
303.710	*180mm	100mm	32.85
303.802	*200mm	20mm	
303.803	*200mm	30mm	34.45
303.804	*200mm	40mm	34.45
303.805	*200mm	50mm	34.45
303.806	*200mm	60mm	34.45
303.807	*200mm	70mm	34.45
303.808	*200mm	80mm	34.45
303.809	*200mm	90mm	34.45
303.810	*200mm	100mm	34.45

Zuschlag für Ausführung in EPS grau Fr.6.50/ml

**EPS - Leibungs- und Sturzelement mit Gewände ohne Falz N°304**

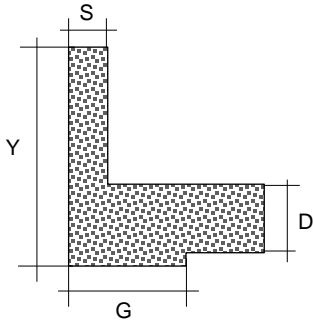

Länge 1000 mm  
**Fassade / Leibung**  
 Schenkellänge aussen 330 / 250 mm  
 Typ \*120 - \*200 330 / 300 mm  
 Y = Variabel auf Anfrage  
 G = Gewände 90 mm, variabel auf Anfrage  
 Leibung Stärke 20mm auf Anfrage  
 Auf Anfrage auch Länge nach Angabe,  
 Montageplatte für Ladenkloben,  
 und Rückhalter Fr.22.45/Stk.  
 Zuschlag Gewebeeinbettung Fr79.80/ml  
 Auf Anfrage auch fein verputzt

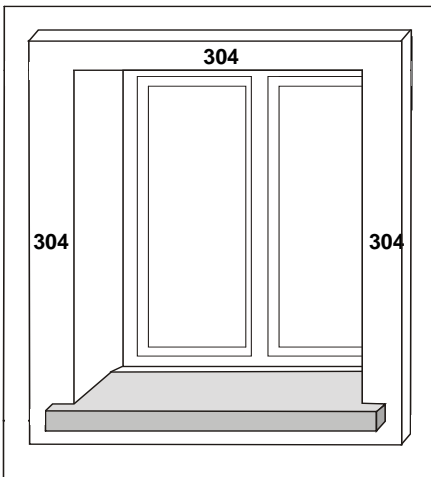
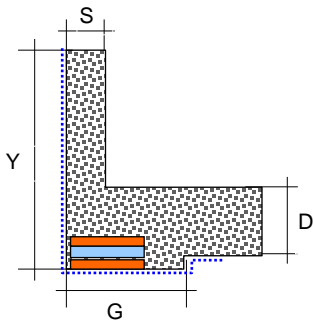

Artikel Nr.	Dicke	Stärke	EPS 20
			Fr. / m <sup>1</sup>
304.202	80mm	20mm	
304.203	80mm	30mm	23.50
304.204	80mm	40mm	23.50
304.205	80mm	50mm	23.50
304.206	80mm	60mm	23.50
304.207	80mm	70mm	23.50
304.208	80mm	80mm	23.50
304.209	80mm	90mm	23.50
304.210	80mm	100mm	23.50
304.302	100mm	20mm	
304.303	100mm	30mm	25.20
304.304	100mm	40mm	25.20
304.305	100mm	50mm	25.20
304.306	100mm	60mm	25.20
304.307	100mm	70mm	25.20
304.308	100mm	80mm	25.20
304.309	100mm	90mm	25.20
304.310	100mm	100mm	25.20
304.402	*120mm	20mm	
304.403	*120mm	30mm	27.35
304.404	*120mm	40mm	27.35
304.405	*120mm	50mm	27.35
304.406	*120mm	60mm	27.35
304.407	*120mm	70mm	27.35
304.408	*120mm	80mm	27.35
304.409	*120mm	90mm	27.35
304.410	*120mm	100mm	27.35
304.502	*140mm	20mm	
304.503	*140mm	30mm	28.40
304.504	*140mm	40mm	28.40
304.505	*140mm	50mm	28.40
304.506	*140mm	60mm	28.40
304.507	*140mm	70mm	28.40
304.508	*140mm	80mm	28.40
304.509	*140mm	90mm	28.40
304.510	*140mm	100mm	28.40
304.602	*160mm	20mm	
304.603	*160mm	30mm	30.10
304.604	*160mm	40mm	30.10
304.605	*160mm	50mm	30.10
304.606	*160mm	60mm	30.10
304.607	*160mm	70mm	30.10
304.608	*160mm	80mm	30.10
304.609	*160mm	90mm	30.10
304.610	*160mm	100mm	30.10
304.702	*180mm	20mm	
304.703	*180mm	30mm	31.70
304.704	*180mm	40mm	31.70
304.705	*180mm	50mm	31.70
304.706	*180mm	60mm	31.70
304.707	*180mm	70mm	31.70
304.708	*180mm	80mm	31.70
304.709	*180mm	90mm	31.70
304.710	*180mm	100mm	31.70
304.802	*200mm	20mm	
304.803	*200mm	30mm	33.25
304.804	*200mm	40mm	33.25
304.805	*200mm	50mm	33.25
304.806	*200mm	60mm	33.25
304.807	*200mm	70mm	33.25
304.808	*200mm	80mm	33.25
304.809	*200mm	90mm	33.25
304.810	*200mm	100mm	33.25

Zuschlag für Ausführung in EPS grau Fr.6.50/ml

**EPS - Leibung mit 3 integrierten Montageplatten zur Befestigung der Ladenkloben und Rückhalter N°370-F**

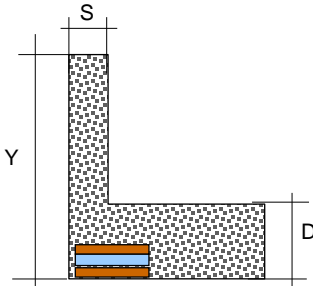

**Fassade / Leibung**

Schenkellänge aussen 330 / 250 mm  
 Typ \*120 - \*200 330 / 300 mm  
 Länge nach Angabe  
 y = Leibungsschenkelhöhe variabel  
 Leibung Stärke 20mm auf Anfrage  
 Zusätzliche Montageplatten

**Pro Stück Fr.22.45**

Auf Anfrage mit PVC Winkel und Gewebeeinbettung  
 Zuschlag Fr.26.50 à ml

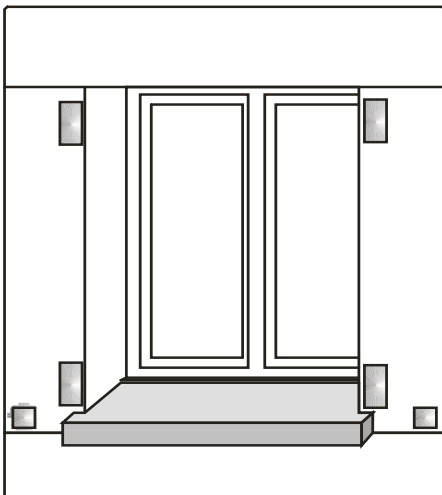
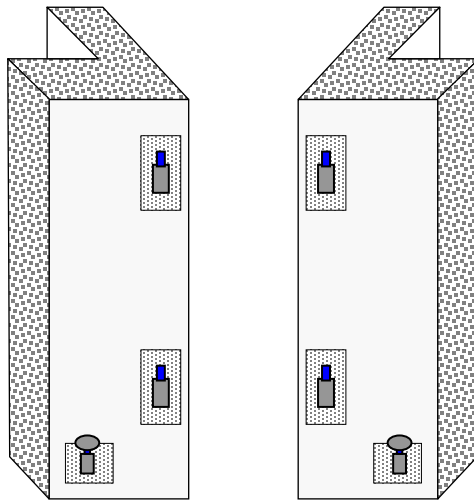

Artikel Nr.	Dicke	Stärke	EPS 20 Fr./Stk.	
			Länge	Fr.
370.202	80mm	20mm	bis 1000mm	<b>82.60</b>
370.203	80mm	30mm	bis 1250mm	<b>88.25</b>
370.204	80mm	40mm	bis 1500mm	<b>93.85</b>
370.205	80mm	50mm	bis 1750mm	<b>99.45</b>
370.206	80mm	60mm	bis 2000mm	<b>105.10</b>
370.207	80mm	70mm	bis 2250mm	<b>110.70</b>
370.208	80mm	80mm	bis 2500mm	<b>116.30</b>
370.209	80mm	90mm		
370.210	80mm	100mm		

Artikel Nr.	Dicke	Stärke	Länge	Fr.
370.302	100mm	20mm	bis 1000mm	<b>83.65</b>
370.303	100mm	30mm	bis 1250mm	<b>89.25</b>
370.304	100mm	40mm	bis 1500mm	<b>94.90</b>
370.305	100mm	50mm	bis 1750mm	<b>100.50</b>
370.306	100mm	60mm	bis 2000mm	<b>106.10</b>
370.307	100mm	70mm	bis 2250mm	<b>111.70</b>
370.308	100mm	80mm	bis 2500mm	<b>117.30</b>
370.309	100mm	90mm		
370.310	100mm	100mm		

Artikel Nr.	Dicke	Stärke	Länge	Fr.
370.402	*120mm	20mm	bis 1000mm	<b>86.20</b>
370.403	*120mm	30mm	bis 1250mm	<b>91.80</b>
370.404	*120mm	40mm	bis 1500mm	<b>97.40</b>
370.405	*120mm	50mm	bis 1750mm	<b>103.00</b>
370.406	*120mm	60mm	bis 2000mm	<b>108.65</b>
370.407	*120mm	70mm	bis 2250mm	<b>114.25</b>
370.408	*120mm	80mm	bis 2500mm	<b>119.85</b>
370.409	*120mm	90mm		
370.410	*120mm	100mm		

Artikel Nr.	Dicke	Stärke	Länge	Fr.
370.502	*140mm	20mm	bis 1000mm	<b>87.70</b>
370.503	*140mm	30mm	bis 1250mm	<b>93.55</b>
370.504	*140mm	40mm	bis 1500mm	<b>99.35</b>
370.505	*140mm	50mm	bis 1750mm	<b>105.20</b>
370.506	*140mm	60mm	bis 2000mm	<b>111.00</b>
370.507	*140mm	70mm	bis 2250mm	<b>116.80</b>
370.508	*140mm	80mm	bis 2500mm	<b>122.60</b>
370.509	*140mm	90mm		
370.510	*140mm	100mm		

Artikel Nr.	Dicke	Stärke	Länge	Fr.
370.602	*160mm	20mm	bis 1000mm	<b>90.30</b>
370.603	*160mm	30mm	bis 1250mm	<b>96.40</b>
370.604	*160mm	40mm	bis 1500mm	<b>102.50</b>
370.605	*160mm	50mm	bis 1750mm	<b>108.65</b>
370.606	*160mm	60mm	bis 2000mm	<b>114.75</b>
370.607	*160mm	70mm	bis 2250mm	<b>120.90</b>
370.608	*160mm	80mm	bis 2500mm	<b>127.00</b>
370.609	*160mm	90mm		
370.610	*160mm	100mm		

Artikel Nr.	Dicke	Stärke	Länge	Fr.
370.702	*180mm	20mm	bis 1000mm	<b>92.80</b>
370.703	*180mm	30mm	bis 1250mm	<b>99.25</b>
370.704	*180mm	40mm	bis 1500mm	<b>105.70</b>
370.705	*180mm	50mm	bis 1750mm	<b>112.10</b>
370.706	*180mm	60mm	bis 2000mm	<b>118.50</b>
370.707	*180mm	70mm	bis 2250mm	<b>124.95</b>
370.708	*180mm	80mm	bis 2500mm	<b>131.40</b>
370.709	*180mm	90mm		
370.710	*180mm	100mm		

Artikel Nr.	Dicke	Stärke	Länge	Fr.
370.802	*200mm	20mm	bis 1000mm	<b>95.40</b>
370.803	*200mm	30mm	bis 1250mm	<b>102.10</b>
370.804	*200mm	40mm	bis 1500mm	<b>108.85</b>
370.805	*200mm	50mm	bis 1750mm	<b>115.60</b>
370.806	*200mm	60mm	bis 2000mm	<b>122.30</b>
370.807	*200mm	70mm	bis 2250mm	<b>129.05</b>
370.808	*200mm	80mm	bis 2500mm	<b>135.80</b>
370.809	*200mm	90mm		
370.810	*200mm	100mm		

Zuschlag für Ausführung in EPS grau Fr.6.50/ml

**EPS - Element mit 3 integrierten Montageplatten  
zur Befestigung der Ladenkloben,  
mit und ohne Rückhalter N°375-T**

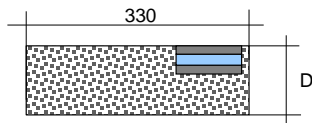

Länge nach Angabe  
Zusätzliche Montageplatten  
Pro Stück Fr.22.45

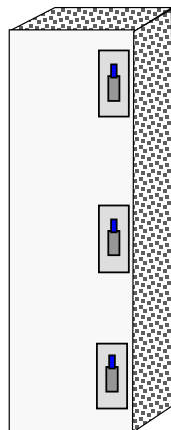

Artikel Nr.	Dicke	EPS 20 Preis Fr.	Stk.bis
375.208	80mm	<b>67.85</b>	1000mm
375.208	80mm	<b>70.20</b>	1250mm
375.208	80mm	<b>72.50</b>	1500mm
375.208	80mm	<b>74.90</b>	1750mm
375.208	80mm	<b>77.20</b>	2000mm
375.208	80mm	<b>79.60</b>	2250mm
375.208	80mm	<b>81.90</b>	2500mm
375.210	100mm	<b>69.40</b>	1000mm
375.210	100mm	<b>72.20</b>	1250mm
375.210	100mm	<b>75.10</b>	1500mm
375.210	100mm	<b>78.00</b>	1750mm
375.210	100mm	<b>80.80</b>	2000mm
375.210	100mm	<b>83.65</b>	2250mm
375.210	100mm	<b>86.50</b>	2500mm
375.212	120mm	<b>71.40</b>	1000mm
375.212	120mm	<b>74.70</b>	1250mm
375.212	120mm	<b>77.95</b>	1500mm
375.212	120mm	<b>81.20</b>	1750mm
375.212	120mm	<b>84.50</b>	2000mm
375.212	120mm	<b>87.70</b>	2250mm
375.212	120mm	<b>91.00</b>	2500mm
375.214	140mm	<b>73.45</b>	1000mm
375.214	140mm	<b>77.20</b>	1250mm
375.214	140mm	<b>81.00</b>	1500mm
375.214	140mm	<b>84.80</b>	1750mm
375.214	140mm	<b>88.55</b>	2000mm
375.214	140mm	<b>92.30</b>	2250mm
375.214	140mm	<b>96.10</b>	2500mm
375.216	160mm	<b>75.00</b>	1000mm
375.216	160mm	<b>79.25</b>	1250mm
375.216	160mm	<b>83.55</b>	1500mm
375.216	160mm	<b>87.80</b>	1750mm
375.216	160mm	<b>92.10</b>	2000mm
375.216	160mm	<b>96.40</b>	2250mm
375.216	160mm	<b>100.70</b>	2500mm
375.218	180mm	<b>77.50</b>	1000mm
375.218	180mm	<b>82.20</b>	1250mm
375.218	180mm	<b>86.90</b>	1500mm
375.218	180mm	<b>91.60</b>	1750mm
375.218	180mm	<b>96.30</b>	2000mm
375.218	180mm	<b>101.00</b>	2250mm
375.218	180mm	<b>105.70</b>	2500mm
375.220	200mm	<b>80.60</b>	1000mm
375.220	200mm	<b>85.80</b>	1250mm
375.220	200mm	<b>91.00</b>	1500mm
375.220	200mm	<b>96.20</b>	1750mm
375.220	200mm	<b>101.40</b>	2000mm
375.220	200mm	<b>106.60</b>	2250mm
375.220	200mm	<b>111.80</b>	2500mm

Zuschlag für Ausführung in EPS grau Fr.6.50/ml



**EPS - Element mit 1 integrierten Montageplatte zur Befestigung der Ladenkloben N°376**

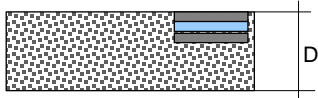

Breite 330 mm  
Höhe 330 mm

Artikel Nr.	Dicke	EPS Preis Fr./Stk.
376.208	80mm	<b>28.60</b>
376.210	100mm	<b>29.70</b>
376.212	120mm	<b>30.60</b>
376.214	140mm	<b>31.40</b>
376.216	160mm	<b>32.45</b>
376.218	180mm	<b>33.60</b>
376.220	200mm	<b>35.30</b>

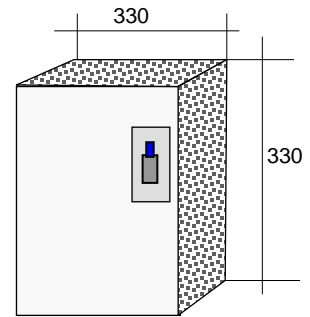

Zuschlag für Ausführung in EPS grau Fr.6.35/ml

**EPS - Element mit 2 integrierten Montageplatten zur Befestigung der Ladenkloben und Rückhalter N°377**

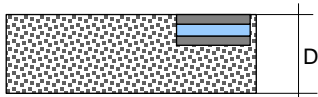

Breite 330 mm  
Höhe 330 mm

Artikel Nr.	Dicke	EPS Preis Fr./Stk.
377.208	80mm	<b>38.80</b>
377.210	100mm	<b>39.80</b>
377.212	120mm	<b>40.80</b>
377.214	140mm	<b>41.80</b>
377.216	160mm	<b>42.85</b>
377.218	180mm	<b>43.90</b>
377.220	200mm	<b>44.90</b>

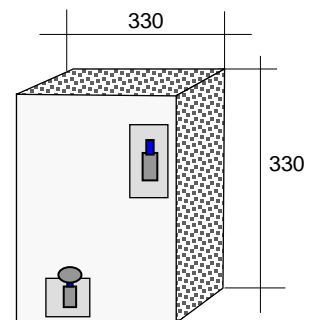

Zuschlag für Ausführung in EPS grau Fr.6.50/ml

### EPS - Element mit 1 integrierten Montageplatte für Anschlageträger der Fensterladen N°380

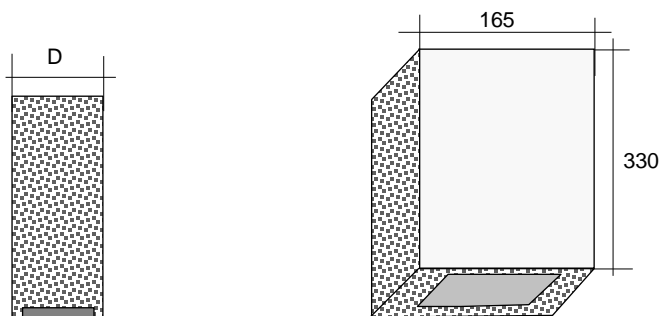

Breite 165 mm  
Höhe 330 mm

Artikel Nr.	Dicke	EPS 20
		Fr./Stk.
380.208	80mm	<b>23.05</b>
380.210	100mm	<b>24.00</b>
380.212	120mm	<b>25.00</b>
380.214	140mm	<b>25.60</b>
380.216	160mm	<b>26.85</b>
380.218	180mm	<b>27.85</b>
380.220	200mm	<b>28.80</b>

Zuschlag für Ausführung in EPS grau Fr.6.50/ml

### EPS - Element mit 1 integrierten Montageplatten zur Befestigung der Rückhalter N°381

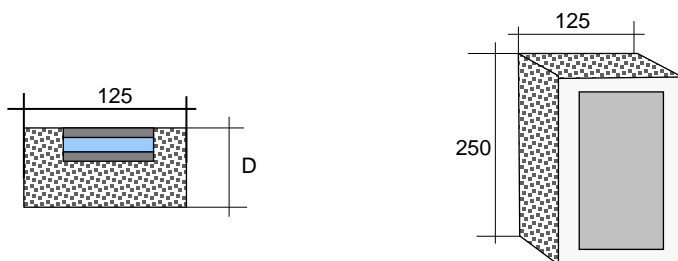

Breite 125 mm  
Höhe 250 mm

Artikel Nr.	Dicke	EPS 20
		Fr./Stk.
381.308	80mm	<b>25.00</b>
381.310	100mm	<b>25.50</b>
381.312	120mm	<b>26.00</b>
381.314	140mm	<b>27.05</b>
381.316	160mm	<b>28.05</b>
381.318	180mm	<b>29.10</b>
381.320	200mm	<b>30.10</b>

### EPS - Montageplatten für Kleiderbügel N°385

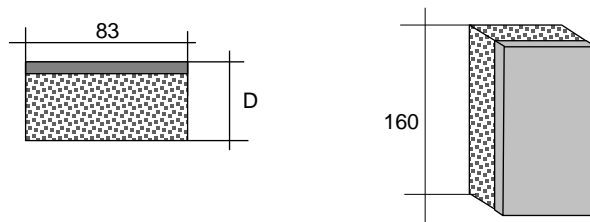

Breite 83 mm  
Höhe 160 mm

Artikel Nr.	Dicke	EPS 20
		Fr./Stk.
385.408	80mm	<b>21.95</b>
385.410	100mm	<b>22.45</b>
385.412	120mm	<b>22.95</b>
385.414	140mm	<b>24.00</b>
385.416	160mm	<b>25.00</b>
385.418	180mm	<b>26.00</b>
385.420	200mm	<b>27.05</b>

**EPS - Fensterbankelement N°145  
( Auflagewinkel )**

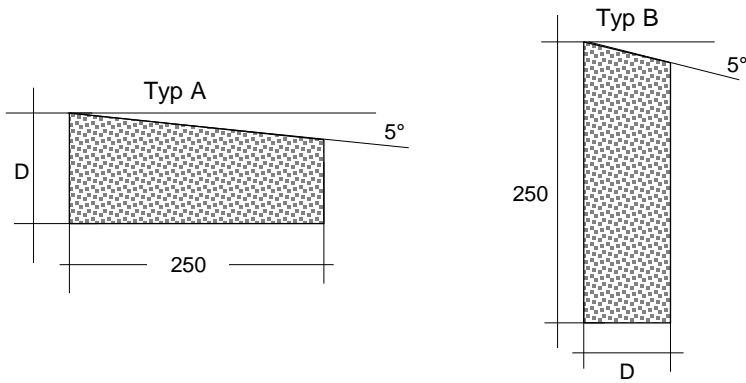

Typ A+B		EPS 20	LAMBDA POR	NEOPOR
Artikel Nr.	Dicke	Fr. / m <sup>1</sup>	Fr. / m <sup>1</sup>	Fr. / m <sup>1</sup>
145.208	80mm	14.65	21.20	21.20
145.210	100mm	16.00	22.45	22.45
145.212	120mm	17.55	24.00	24.00
145.214	140mm	19.10	25.60	25.60
145.216	160mm	20.90	27.40	27.40
145.218	180mm	22.75	29.30	29.30
145.220	200mm	24.70	31.20	31.20
145.222	220mm	26.85	33.30	33.30

Länge 1000 mm  
 Schenkellänge 250 mm  
 Auf Anfrage aus extrudiertem Polystyrol

**EPS - Fensterbankelement N°150  
( Auflagewinkel )**

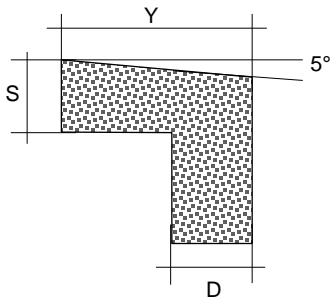

Artikel Nr.	Dicke	Stärke	EPS 20	LAMBDA POR	NEOPOR
			Fr. / m <sup>1</sup>	Fr. / m <sup>1</sup>	Fr. / m <sup>1</sup>
150.208	80mm	80mm	20.45	26.95	26.95
150.210	100mm	100mm	21.70	28.15	28.15
150.212	120mm	120mm	23.30	29.75	29.75
150.214	*140mm	140mm	24.95	31.40	31.40
150.216	*160mm	160mm	26.85	33.35	33.35
150.218	*180mm	180mm	28.50	35.00	35.00
150.220	*200mm	200mm	30.45	36.90	36.90
150.222	*220mm	220mm	32.80	39.30	39.30

Länge 1000 mm  
 Stärke und Banktiefe ( Y ) variabel  
**Fassade / Bank**  
 Schenkellänge aussen 250 / 250 mm  
 \*Typ 140 - 220 250 / 300 mm  
 Auf Anfrage aus extrudiertem Polystyrol

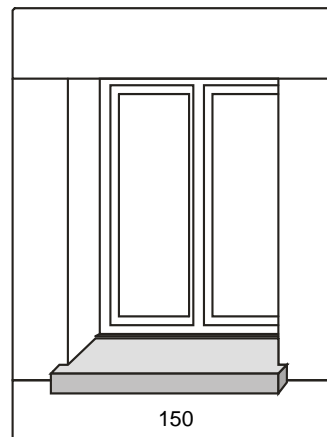
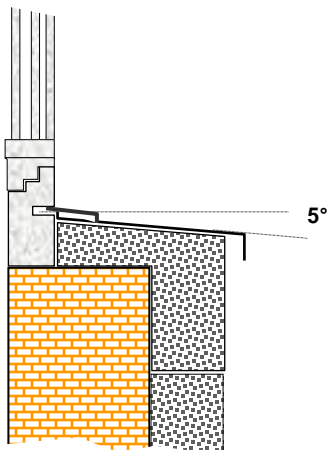

## EPS - Universal Eckelement N°101

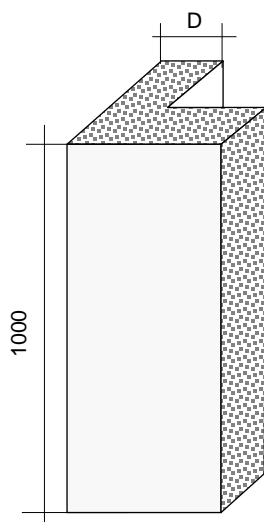

Länge 1000 mm  
 Schenkellänge aussen 200 / 250 mm  
 \*Typ 140 - 200 250 / 300 mm

Artikel Nr.	Dicke	EPS 20
		Fr. / m <sup>3</sup>
101.208	80mm	<b>19.45</b>
101.210	100mm	<b>21.10</b>
101.212	120mm	<b>22.90</b>
101.214	*140mm	<b>25.25</b>
101.216	*160mm	<b>26.85</b>
101.218	*180mm	<b>28.70</b>
101.220	*200mm	<b>29.75</b>

Zuschlag für Ausführung in EPS grau Fr.6.50/ml

## EPS - Eckelement für Standard Fassadenplatten N°105

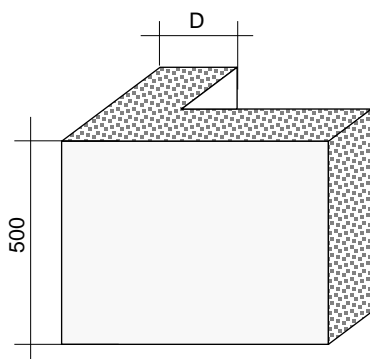

Höhe 500 mm  
 Schenkellänge aussen 250 / 495 mm

Artikel Nr.	Dicke	EPS 20
		Fr. pro Stk.
105.208	80mm	<b>19.45</b>
105.210	100mm	<b>21.10</b>
105.212	120mm	<b>22.90</b>
105.214	140mm	<b>25.25</b>
105.216	160mm	<b>26.85</b>
105.218	180mm	<b>28.70</b>
105.220	200mm	<b>29.75</b>

Zuschlag für Ausführung in EPS grau Fr.6.50/ml

## EPS - Dilatationsfugen Eckelement N°120

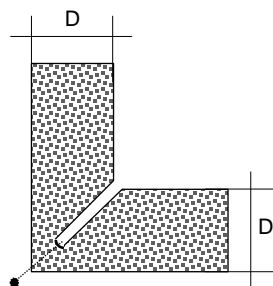

Länge 1000 mm  
 Schenkellänge aussen 200 / 250 mm  
 \*Typ 140 - 200 250 / 300 mm  
 Bauseitig abschneiden nach Montage

Preis auf Anfrage		EPS 20
Artikel Nr.	Dicke	Fr. / m <sup>3</sup>
120.208	80mm	
120.210	100mm	
120.212	120mm	
120.214	*140mm	
120.216	*160mm	
120.218	*180mm	
120.220	*200mm	

**Kombiniertes - EPS / Mineralisches Schürzenelement mit PVC Winkel, Schiene und Gewebeeinbettung N° 400-K**

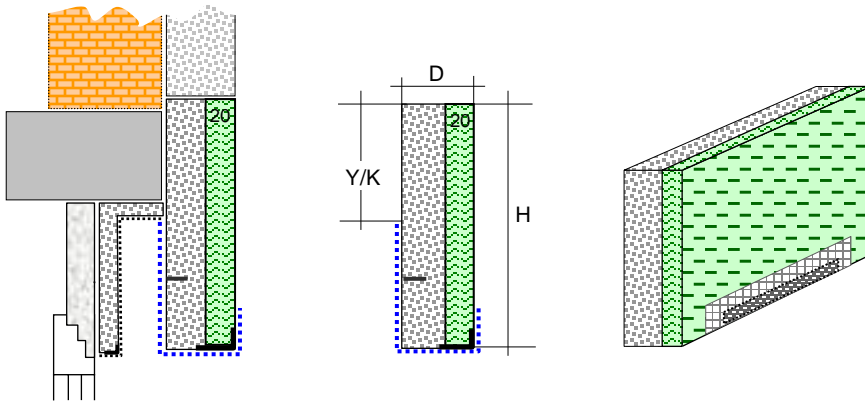

Länge nach Angabe  
Y/K = Variabel ( Klebefläche )  
Auf Anfrage andere Höhe

Höhe 500 mm		Kombiniert
Artikel Nr.	Dicke	Fr. / m <sup>1</sup>
400.453-K	30mm	94.55
400.454-K	40mm	72.90
400.455-K	50mm	76.00
400.456-K	60mm	77.35
400.457-K	70mm	78.00
400.458-K	80mm	79.95
400.459-K	90mm	81.75
400.460-K	100mm	83.05
400.461-K	110mm	85.65
400.462-K	120mm	87.55
400.463-K	130mm	90.20
400.464-K	140mm	90.75
400.465-K	150mm	93.25
400.466-K	160mm	95.25
400.467-K	170mm	97.75
400.468-K	180mm	99.65
400.469-K	190mm	102.20
400.470-K	200mm	104.15

**EPS - Aufdoppelung N° 440**

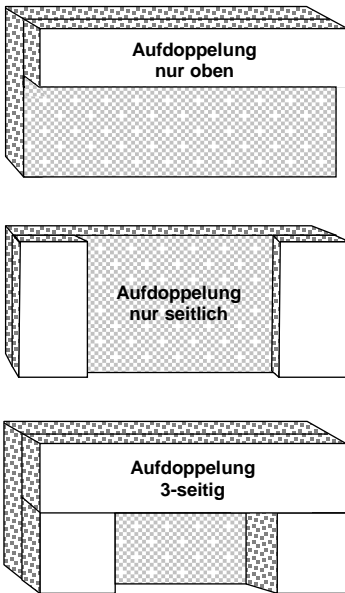

Aufdoppelung  
Nur oben oder Nur seitlich

Artikel Nr.	Stärke	Fr. / m <sup>1</sup>
440.831	10mm	10.75
440.832	20mm	10.75
440.833	30mm	11.30
440.834	40mm	11.80
440.835	50mm	12.35
440.836	60mm	12.90
440.837	70mm	13.95
440.838	80mm	15.00
440.839	90mm	15.60
440.840	100mm	16.10
440.841	110mm	17.70
440.842	120mm	18.80
440.843	130mm	19.30
440.844	140mm	19.85
440.845	150mm	20.95
440.846	160mm	21.45
440.847	170mm	22.00
440.848	180mm	22.50
440.849	190mm	23.60
440.850	200mm	24.65

Aufdoppelung  
3-Seitig

Artikel Nr.	Stärke	Fr. / m <sup>1</sup>
440.931	10mm	15.00
440.932	20mm	15.00
440.933	30mm	15.60
440.934	40mm	16.10
440.935	50mm	16.65
440.936	60mm	17.70
440.937	70mm	18.80
440.938	80mm	19.85
440.939	90mm	20.40
440.940	100mm	20.95
440.941	110mm	22.00
440.942	120mm	23.10
440.943	130mm	23.60
440.944	140mm	24.15
440.945	150mm	25.20
440.946	160mm	25.75
440.947	170mm	26.30
440.948	180mm	26.80
440.949	190mm	27.85
440.950	200mm	29.50

**Zuschläge :**

**Vormontierter Montagewinkel**  
für Balkondecke, Artikel Nr. 480.001 Pro Stück Fr. 19.30

Zuschlag für Ausführung in **EPS grau** Fr.6.00/ml

480.007 **Mehrhöhe** pro cm Fr.1.40/ml

480.915 **Minderhöhe** <500mm Fr.2.--/ml

480.008 **Mehrlänge** 3001-4500mm Fr.2.50/ml

480.004 ab **4500mm Dilatation Längestösse** mit Gewebe und Metallschiene Fr. 23.85/Stk.

480.015 Integrierter **PVC Tropfkanteprofil** Fr.20.95/ml

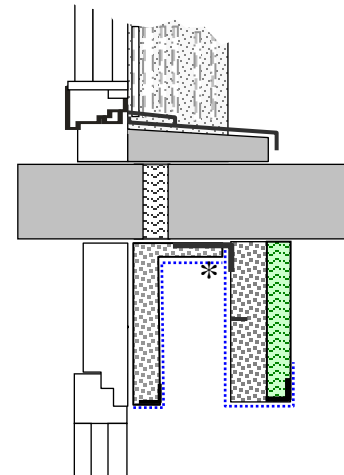
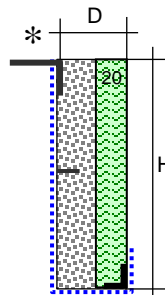

**Kombiniertes - EPS - Mineralisches Fensterbankelement N°150-K  
( Auflagewinkel )**

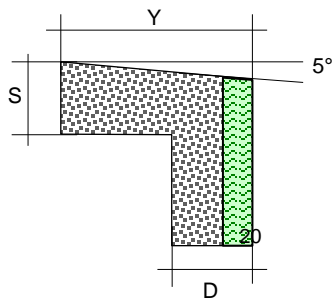

Artikel Nr.	Dicke	Stärke	Kombiniertes
			Fr. / m <sup>1</sup>
150.208-K	80mm	80mm	37.75
150.210-K	100mm	100mm	39.10
150.212-K	120mm	120mm	40.60
150.214-K	*140mm	140mm	42.20
150.216-K	*160mm	160mm	43.90
150.218-K	*180mm	180mm	45.80
150.220-K	*200mm	200mm	47.75
150.222-K	*220mm	220mm	49.90

Länge 1000 mm  
 Stärke und Banktiefe ( Y ) variabel  
**Fassade / Bank**  
 Schenkellänge aussen 250 / 250 mm  
 \*Typ 140 - 220 250 / 300 mm

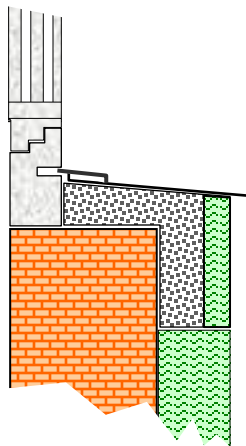

**Kombiniertes - EPS - Mineralisches Dachrandwinkel N°525 - K**

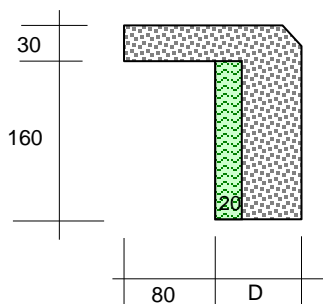

Artikel Nr.	Dicke	Stärke	Kombiniertes
			Fr. / m <sup>1</sup>
525.308-K	80mm	30mm	31.40
525.310-K	100mm	30mm	33.50
525.312-K	120mm	30mm	35.65
525.314-K	140mm	30mm	37.65
525.316-K	160mm	30mm	39.65
525.318-K	180mm	30mm	41.70
525.320-K	200mm	30mm	43.80

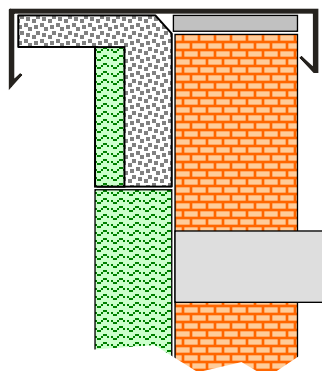

**Kombiniertes - EPS - Mineralisches Leibungs- und Sturzelement N°301-K**

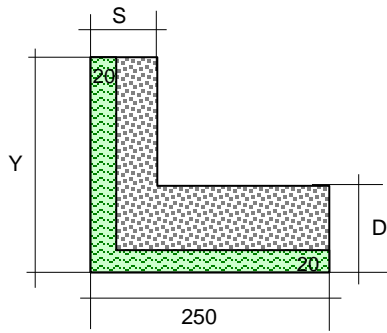

Länge 1000 mm  
 Fassade / Leibung  
 Schenkellänge aussen 250 / 250 mm  
 Typ \*120 - \*200 250 / 300 mm  
 Y = Leibungsschenkellänge variabel  
 Stärke 20 und 30 mm auf Anfrage

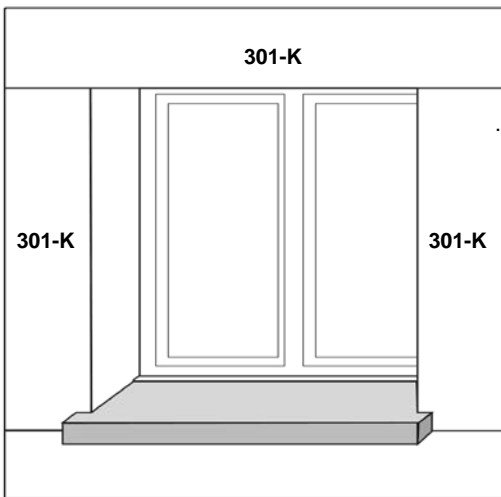
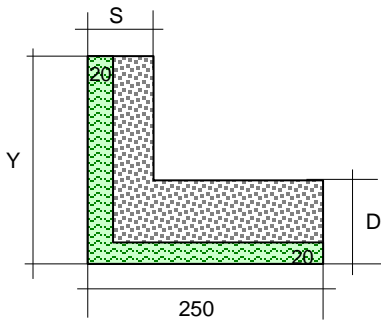

Preis auf Anfrage			Kombiniertes
Artikel Nr.	Dicke	Stärke	Fr. / m <sup>3</sup>
301.202-K	80mm	20mm	
301.203-K	80mm	30mm	
301.204-K	80mm	40mm	
301.205-K	80mm	50mm	
301.206-K	80mm	60mm	
301.207-K	80mm	70mm	
301.208-K	80mm	80mm	
301.209-K	80mm	90mm	
301.210-K	80mm	100mm	
301.302-K	100mm	20mm	
301.303-K	100mm	30mm	
301.304-K	100mm	40mm	
301.305-K	100mm	50mm	
301.306-K	100mm	60mm	
301.307-K	100mm	70mm	
301.308-K	100mm	80mm	
301.309-K	100mm	90mm	
301.310-K	100mm	100mm	
301.402-K	*120mm	20mm	
301.403-K	*120mm	30mm	
301.404-K	*120mm	40mm	
301.405-K	*120mm	50mm	
301.406-K	*120mm	60mm	
301.407-K	*120mm	70mm	
301.408-K	*120mm	80mm	
301.409-K	*120mm	90mm	
301.410-K	*120mm	100mm	
301.502-K	*140mm	20mm	
301.503-K	*140mm	30mm	
301.504-K	*140mm	40mm	
301.505-K	*140mm	50mm	
301.506-K	*140mm	60mm	
301.507-K	*140mm	70mm	
301.508-K	*140mm	80mm	
301.509-K	*140mm	90mm	
301.510-K	*140mm	100mm	
301.602-K	*160mm	20mm	
301.603-K	*160mm	30mm	
301.604-K	*160mm	40mm	
301.605-K	*160mm	50mm	
301.606-K	*160mm	60mm	
301.607-K	*160mm	70mm	
301.608-K	*160mm	80mm	
301.609-K	*160mm	90mm	
301.610-K	*160mm	100mm	
301.702-K	*180mm	20mm	
301.703-K	*180mm	30mm	
301.704-K	*180mm	40mm	
301.705-K	*180mm	50mm	
301.706-K	*180mm	60mm	
301.707-K	*180mm	70mm	
301.708-K	*180mm	80mm	
301.709-K	*180mm	90mm	
301.710-K	*180mm	100mm	
301.802-K	*200mm	20mm	
301.803-K	*200mm	30mm	
301.804-K	*200mm	40mm	
301.805-K	*200mm	50mm	
301.806-K	*200mm	60mm	
301.807-K	*200mm	70mm	
301.808-K	*200mm	80mm	
301.809-K	*200mm	90mm	
301.810-K	*200mm	100mm	

**Kombiniertes - EPS - Mineralisches Leibungselement mit Metalleinlage zur Befestigung der Rolladenschiene N°301 - K/R**

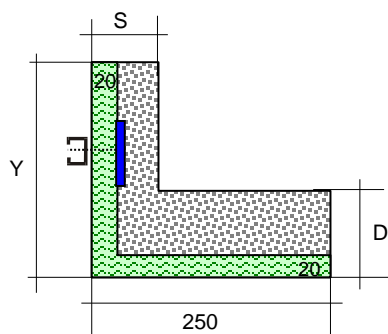

Länge 1000 mm

Fassade / Leibung

Schenkellänge aussen 250 / 250 mm

Typ \*120 - \*200 250 / 300 mm

Y = Leibungsschenkellänge variabel

Stärke 20 und 30 mm auf Anfrage

Auf Anfrage mit PVC Winkel und Gewebeeinbettung

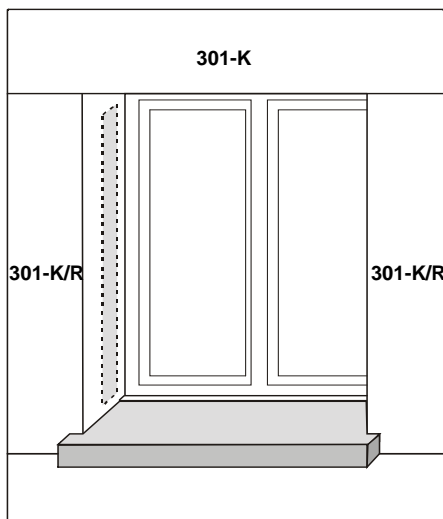
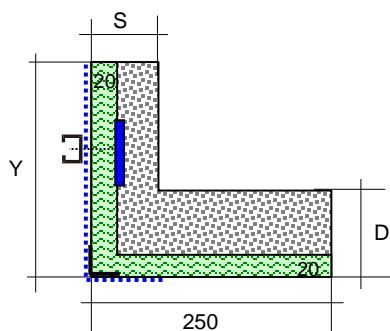

Preis auf Anfrage

Kombiniertes

Artikel Nr.	Dicke	Stärke	Fr. / m <sup>1</sup>
301.202-K/R	80mm	20mm	
301.203-K/R	80mm	30mm	
301.204-K/R	80mm	40mm	
301.205-K/R	80mm	50mm	
301.206-K/R	80mm	60mm	
301.207-K/R	80mm	70mm	
301.208-K/R	80mm	80mm	
301.209-K/R	80mm	90mm	
301.210-K/R	80mm	100mm	
301.302-K/R	100mm	20mm	
301.303-K/R	100mm	30mm	
301.304-K/R	100mm	40mm	
301.305-K/R	100mm	50mm	
301.306-K/R	100mm	60mm	
301.307-K/R	100mm	70mm	
301.308-K/R	100mm	80mm	
301.309-K/R	100mm	90mm	
301.310-K/R	100mm	100mm	
301.402-K/R	*120mm	20mm	
301.403-K/R	*120mm	30mm	
301.404-K/R	*120mm	40mm	
301.405-K/R	*120mm	50mm	
301.406-K/R	*120mm	60mm	
301.407-K/R	*120mm	70mm	
301.408-K/R	*120mm	80mm	
301.409-K/R	*120mm	90mm	
301.410-K/R	*120mm	100mm	
301.502-K/R	*140mm	20mm	
301.503-K/R	*140mm	30mm	
301.504-K/R	*140mm	40mm	
301.505-K/R	*140mm	50mm	
301.506-K/R	*140mm	60mm	
301.507-K/R	*140mm	70mm	
301.508-K/R	*140mm	80mm	
301.509-K/R	*140mm	90mm	
301.510-K/R	*140mm	100mm	
301.602-K/R	*160mm	20mm	
301.603-K/R	*160mm	30mm	
301.604-K/R	*160mm	40mm	
301.605-K/R	*160mm	50mm	
301.606-K/R	*160mm	60mm	
301.607-K/R	*160mm	70mm	
301.608-K/R	*160mm	80mm	
301.609-K/R	*160mm	90mm	
301.610-K/R	*160mm	100mm	
301.702-K/R	*180mm	20mm	
301.703-K/R	*180mm	30mm	
301.704-K/R	*180mm	40mm	
301.705-K/R	*180mm	50mm	
301.706-K/R	*180mm	60mm	
301.707-K/R	*180mm	70mm	
301.708-K/R	*180mm	80mm	
301.709-K/R	*180mm	90mm	
301.710-K/R	*180mm	100mm	
301.802-K/R	*200mm	20mm	
301.803-K/R	*200mm	30mm	
301.804-K/R	*200mm	40mm	
301.805-K/R	*200mm	50mm	
301.806-K/R	*200mm	60mm	
301.807-K/R	*200mm	70mm	
301.808-K/R	*200mm	80mm	
301.809-K/R	*200mm	90mm	
301.810-K/R	*200mm	100mm	



**Kombiniertes - EPS - Mineralische Leibung mit 3 integrierten Montageplatten zur Befestigung der Ladenkloben und Rückhalter N°370-K**

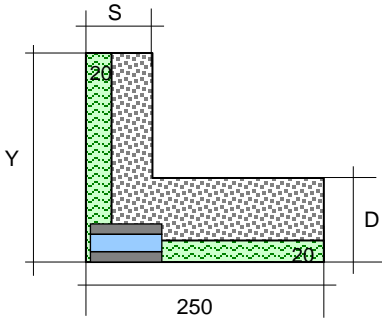

Länge nach Angabe

**Fassade / Leibung**

Schenkellänge aussen 330 / 250 mm

Typ \*120 - \*200 330 / 300 mm

Y = Leibungsschenkellänge variabel

Stärke 20 und 30 mm auf Anfrage

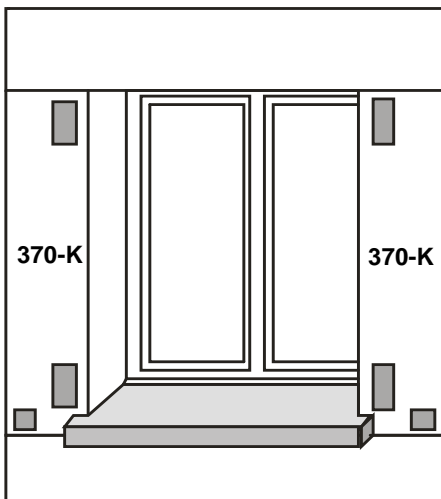

Preis auf Anfrage			Kombiniertes
Artikel Nr.	Dicke	Stärke	Fr. / m <sup>1</sup>
370.202-K	80mm	20mm	
370.203-K	80mm	30mm	
370.204-K	80mm	40mm	
370.205-K	80mm	50mm	
370.206-K	80mm	60mm	
370.207-K	80mm	70mm	
370.208-K	80mm	80mm	
370.209-K	80mm	90mm	
370.210-K	80mm	100mm	
370.302-K	100mm	20mm	
370.303-K	100mm	30mm	
370.304-K	100mm	40mm	
370.305-K	100mm	50mm	
370.306-K	100mm	60mm	
370.307-K	100mm	70mm	
370.308-K	100mm	80mm	
370.309-K	100mm	90mm	
370.310-K	100mm	100mm	
370.402-K	*120mm	20mm	
370.403-K	*120mm	30mm	
370.404-K	*120mm	40mm	
370.405-K	*120mm	50mm	
370.406-K	*120mm	60mm	
370.407-K	*120mm	70mm	
370.408-K	*120mm	80mm	
370.409-K	*120mm	90mm	
370.410-K	*120mm	100mm	
370.502-K	*140mm	20mm	
370.503-K	*140mm	30mm	
370.504-K	*140mm	40mm	
370.505-K	*140mm	50mm	
370.506-K	*140mm	60mm	
370.507-K	*140mm	70mm	
370.508-K	*140mm	80mm	
370.509-K	*140mm	90mm	
370.510-K	*140mm	100mm	
370.602-K	*160mm	20mm	
370.603-K	*160mm	30mm	
370.604-K	*160mm	40mm	
370.605-K	*160mm	50mm	
370.606-K	*160mm	60mm	
370.607-K	*160mm	70mm	
370.608-K	*160mm	80mm	
370.609-K	*160mm	90mm	
370.610-K	*160mm	100mm	
370.702-K	*180mm	20mm	
370.703-K	*180mm	30mm	
370.704-K	*180mm	40mm	
370.705-K	*180mm	50mm	
370.706-K	*180mm	60mm	
370.707-K	*180mm	70mm	
370.708-K	*180mm	80mm	
370.709-K	*180mm	90mm	
370.710-K	*180mm	100mm	
370.802-K	*200mm	20mm	
370.803-K	*200mm	30mm	
370.804-K	*200mm	40mm	
370.805-K	*200mm	50mm	
370.806-K	*200mm	60mm	
370.807-K	*200mm	70mm	
370.808-K	*200mm	80mm	
370.809-K	*200mm	90mm	
370.810-K	*200mm	100mm	

## **Verkaufs und Lieferbedingungen**

### **1 Angebote / Exklusivität**

Angebote verstehen sich generell und ohne besonderen Hinweis freibleibend. Die Produkte ARTISOL System dürfen ausschliesslich über die ARTISOL GmbH Winterthur gekauft werden. Die ARTISOL System Fertigelemente dürfen weder in der Form verändert noch nachgerüstet werden.

### **2 Preise**

Die Preise verstehen sich exklusive Mehrwertsteuer. Preisänderungen in der Preisliste bleiben jederzeit vorbehalten und erfordern keine Voranzeige.

### **3 Liefertermine**

Die Festsetzung von Lieferterminen erfolgt nach sorgfältigem Ermessen, bleibt jedoch unverbindlich. Nicht ausgeführte oder verspätete Lieferungen berechtigen den Käufer weder zum Rücktritt von seiner Bestellung noch zu irgendwelchen Ansprüchen, namentlich Schadenersatz. Teillieferungen sind möglich. Höhere Gewalt wie z.B. Waren- oder Rohstoffmangel, Ausfall von Maschinen usw. bleibt vorbehalten.

### **4 Lieferungen**

Ohne anderslautende Vereinbarung wird die Versandart nach dem Ermessen des Verkäufers bestimmt. Lieferungen an Nettowarenwert von Fr.3500.- erfolgen franko LKW-zugänglicher Baustelle, Lager oder SBB Talbahnstation in der Schweiz. Für sämtliche Schürzenelemente und Elemente mit Spezialanfertigung gilt als Abholort bindend das Lager der Firma ARTISOL GmbH. Mit Unterzeichnung der Lieferscheinkopie wird bestätigt, dass alle bestellten Waren ausgeliefert bzw. aufgeladen wurden und keine Beschädigungen vorlagen. Lieferkosten für Lieferungen unter Fr.3500.- netto gehen zu Lasten des Käufers. Nicht zurückgegeben oder ausgetauschte Paletten werden verrechnet. Die Ware reist auf Rechnung und Gefahr des Käufers. Der Ablad erfolgt durch den Warenempfänger.

### **5 Reklamationen**

Reklamationen werden nur innert 5 Arbeitstagen nach Warenempfang entgegengenommen und vor deren Montage oder Verlegung. Die Artisol GmbH ist bemüht, nur einwandfreie Ware auszuliefern. Sollte bei einer Lieferung trotzdem etwas nicht in Ordnung sein, bitten wir Sie, uns sofort nach Erhalt der Ware zu informieren. Mängel an montierten Elementen können nicht mehr berücksichtigt werden. Forderungen gleich welcher Art werden nur nach vorheriger Absprache, sowie einer schriftlichen Zusage akzeptiert. Anpassungs und Egalisierarbeiten die bei der Montage vorgenommen werden müssen, gelten nicht als Produktmängel.

### **6 Retouren / Vergütungen**

Retouren von Waren sind grundsätzlich nur mit dem Einverständnis des Verkäufers zulässig. Die Transport- und allfällige Entsorgungskosten gehen zu Lasten des Käufers. Die Vergütung beträgt max. 75 % vom Fakturawert. Deren Höhe wird erst im Werk festgelegt und richtet sich nach der Wiederverwendbarkeit der Produkte.

### **7 Garantiebestimmungen / Haftung**

ARTISOL leistet für von Ihr konstruierte und gefertigte Elemente dem Käufer 5 Jahre Garantie für technische Tauglichkeit und Witterungsbeständigkeit, sofern nach der Auslieferung keine Änderung angebracht und sie vorschriftskonform verarbeitet wurden. Diese Garantie umfasst das Recht auf Nachbesserung resp. Ersatzlieferung. Die Garantiefrist beginnt ab Fakturadatum. Die Haftung für einen allfälligen Schaden wird ausdrücklich auf den Betrag des Kaufpreises beschränkt. Weitergehende Schadenersatzforderungen sind ausgeschlossen.

### **8 Zahlungskonditionen**

Die Rechnungen sind zahlbar innert 30 Tagen netto ab Fakturadatum. Der Verkäufer ist befugt, unberechtigte Skontoabzüge nachzufordern. Wird die Zahlungsfrist überschritten, wird ein Verzugszins von 6% ab Fälligkeit des Datum angerechnet.

### **9 Geltungsbereich**

Die vorliegenden Verkauf- und Lieferbedingungen treten stillschweigend bei Auftragserteilung bzw. Offertstellung in Kraft

### **10 Gerichtsstand**

Alle Angaben entsprechen bei Drucklegung dem Stand der Technik. Gewährleistung bzw. eine Rechtspflicht für den Anwendungsfall kann daraus nicht abgeleitet werden, da Ausführungs- und Arbeitsbedingungen ausserhalb unserer Kontrolle stehen. Änderungen/ Weiterentwicklungen bleiben generell vorbehalten. Gerichtsstand aus Streitigkeiten aus den vorliegenden Bedingungen ist das jeweilige Domizil des Verkäufers.